



Retractable Pergolas



The Palmiye Company commenced trading within the construction industry in 1998. Focusing mainly on Scandinavia, Europe and the Middle East, this young company achieved well deserved respect and confidence by successfully constructing the world's largest awning project in Norway in 2002, thereby presenting the brand 'Palmiye' to the awning and shading sector.

Benefiting from its international network and extended organizational structure, Palmiye is now represented in many countries worldwide and the values of each and every culture combined with unique architectural concepts, inspire and are reflected in Palmiye's products.

As a progressive innovator, Palmiye operates with sensitivity, tailoring distinctive and unique products, in which the feelings and styles of world famous architects and designers are translated into life.

Following the completion of the Norwegian project in 2003, Palmiye focused on research and development, subsequently introducing the first motorised pergola to the market in 2004, and then in 2006 making the addition of a pergola intended to be used for all 4 seasons. In 2011 Palmiye further widened their operational horizons, by developing a partnership with Lugano Glass, a company partially owned by Courage Investments, an English holding company.

The value and inspiration resulting from each different culture with its unique architectural concepts, is reflected in every one of Palmiye's products. Today as an advanced innovator, Palmiye with many different sales points in 6 continents offers the widest range of Pergola designs and solutions in the world, together with a multitude of shading systems.

index

06
SILVER

12
TRUMP

16
CORAL

44
PAVILION
AAA

54
PANORAMA

62
ALBATROS

76
BRIDGE

22
BRILLIANT

28
GALA

34
CROWN

78
MARIN

84
LEGEND

88
COSMO

92
DETAILS
&
OPTIONS



SILVER

With its clean lines and modern design, Silver is an unobtrusive yet stylish way to get the best out of your outdoor area, distinguishing itself from other establishments in the neighbourhood.



SILVER

ECO TILTED

Silver Eco is a compact retractable roof system, adapted to an aluminium structure. Contemporary and stylish, Silver Eco is an attractive addition to your outdoor area.

Palmiye presents a wide range of ceiling covers, with a selection of colours, materials and patterns which are imported from Europe and U.S, with 5 years warranty against fading and mould.

The entire drainage system is integrated into the structure and lighting systems can be adapted to the ceiling cover which moves together with it.

The Spot Lights or Linear Lights are installed on the aluminium profiles and can be controlled by a remote control or with a remote controlled dimmer function.

Each of our products is hand crafted and in itself unique and from ceiling cover to construction material, you can completely customize your products.

Palmiye is proud to present its own MyPalmiye App which has been designed specifically for Palmiye products and is available at Apple's App Store.

width	1300
projection	600
max rail centers	450

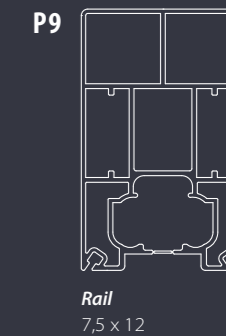
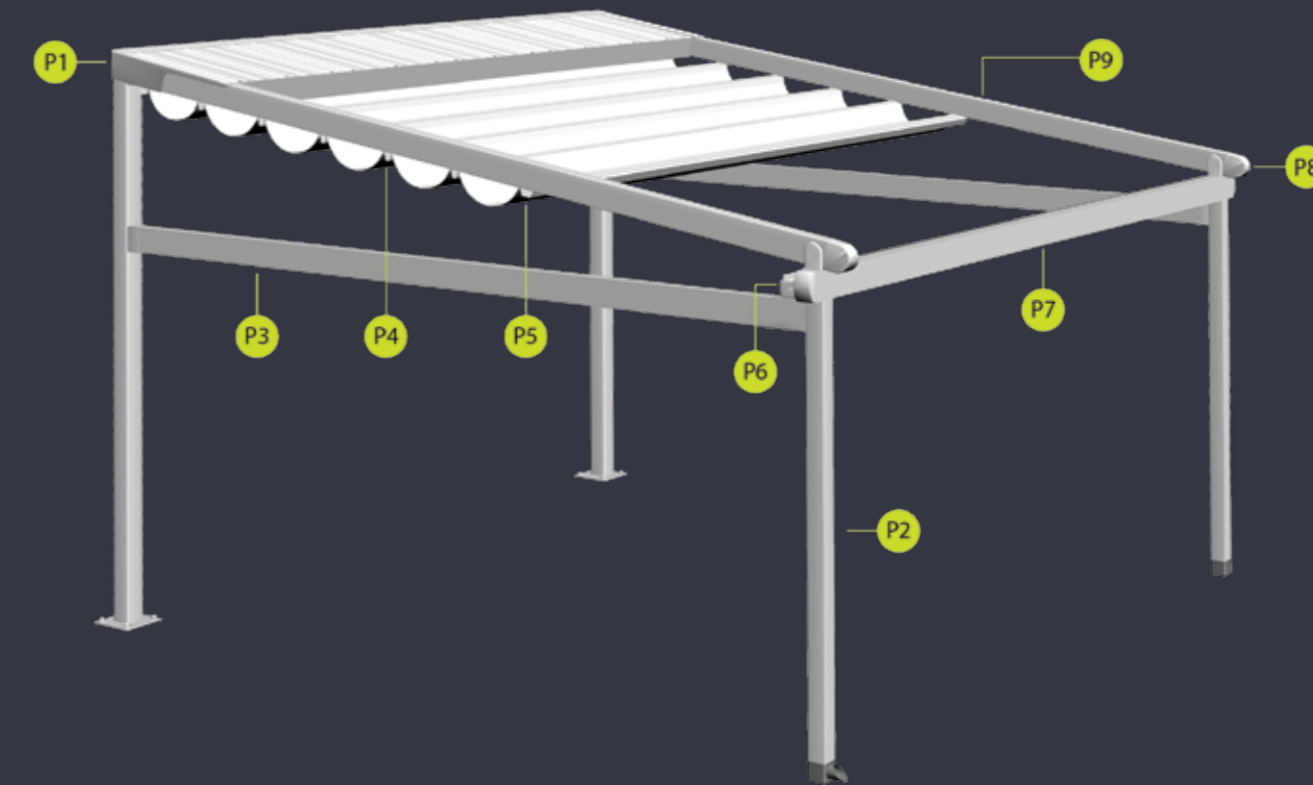
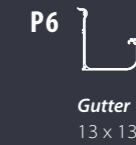
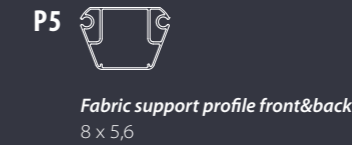
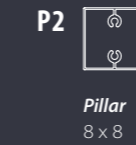
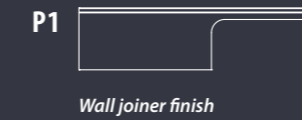
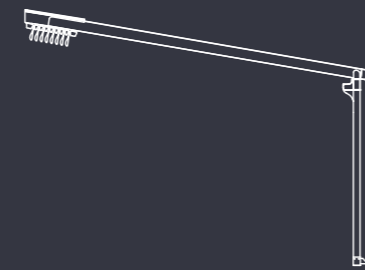



SILVER

TILTED

Silver is a retractable roof system, adapted to aluminium structure. With its clean and modern design, Four Seasons Silver adds value to your outdoor areas.

The product is usable according to its User Manual in all-weather conditions and designed to be used in all four seasons. If desired the product can be made into retractable winter garden by closing the sides with different kinds of enclosures.

Palmiye presents a wide range of ceiling covers, with a selection of colours, materials, (such as PVC, fabric) and patterns which are imported from Europe and U.S, with 5 years guaranty against fading and mould.

width	1300
projection	1000
max rail centers	450

The entire drainage system is integrated into the structure and lighting systems can be adapted to the ceiling cover which moves together with it. The Spot Lights or Linear Lights are installed on the aluminium profiles and can be controlled by a remote control or with a remote controlled dimmer function.

Each of our products is hand crafted and in itself unique, and from ceiling cover to construction material, you can completely customize your products.

Palmiye is proud to present its own MyPalmiye App which has been designed specifically for Palmiye products and is available at Apple's App Store.

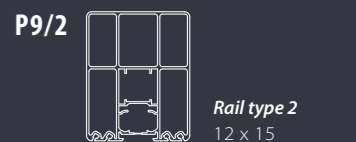
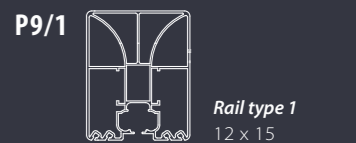
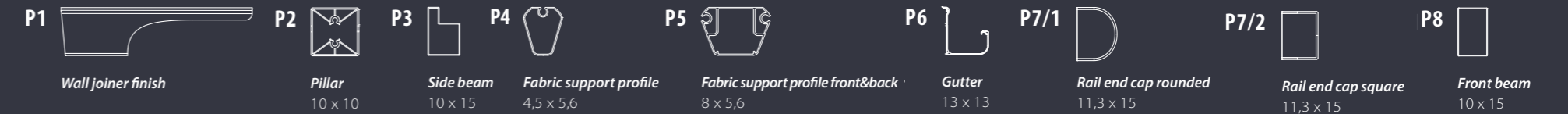
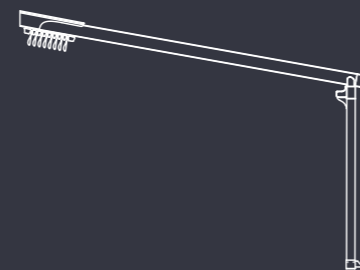



TRUMP

The epitome of relaxation, with its clean lines and modern design Trump will protect, enhance and soothe at the same time.

Be at one with nature, and experience the therapy of the great outdoors, throughout the year.



TRUMP

FLAT

It is a special designed retractable roof system with its flat aluminium construction.

Palmiye presents a wide range of ceiling covers, with a selection of colours, material (such as PVC, fabric) and patterns which are imported from Europe and U.S, with 5 years guaranty against fading and mould.

Lighting systems can be adapted to the ceiling cover which moves together with it. The Spot Lights or Linear Lights are installed on the aluminium profiles and can be controlled by a remote control or with a remote controlled dimmer function.

Each of our products is hand crafted and in itself unique, and from ceiling cover to the construction material you can completely customize your products.

Palmiye is proud to present its own MyPalmiye App which has been designed specifically for Palmiye products and is available at Apple's App Store.

width	1300
projection	800
max rail centers	450

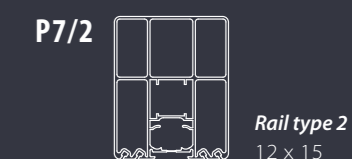
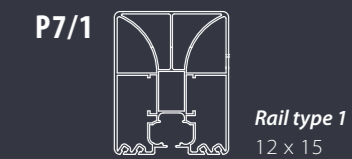
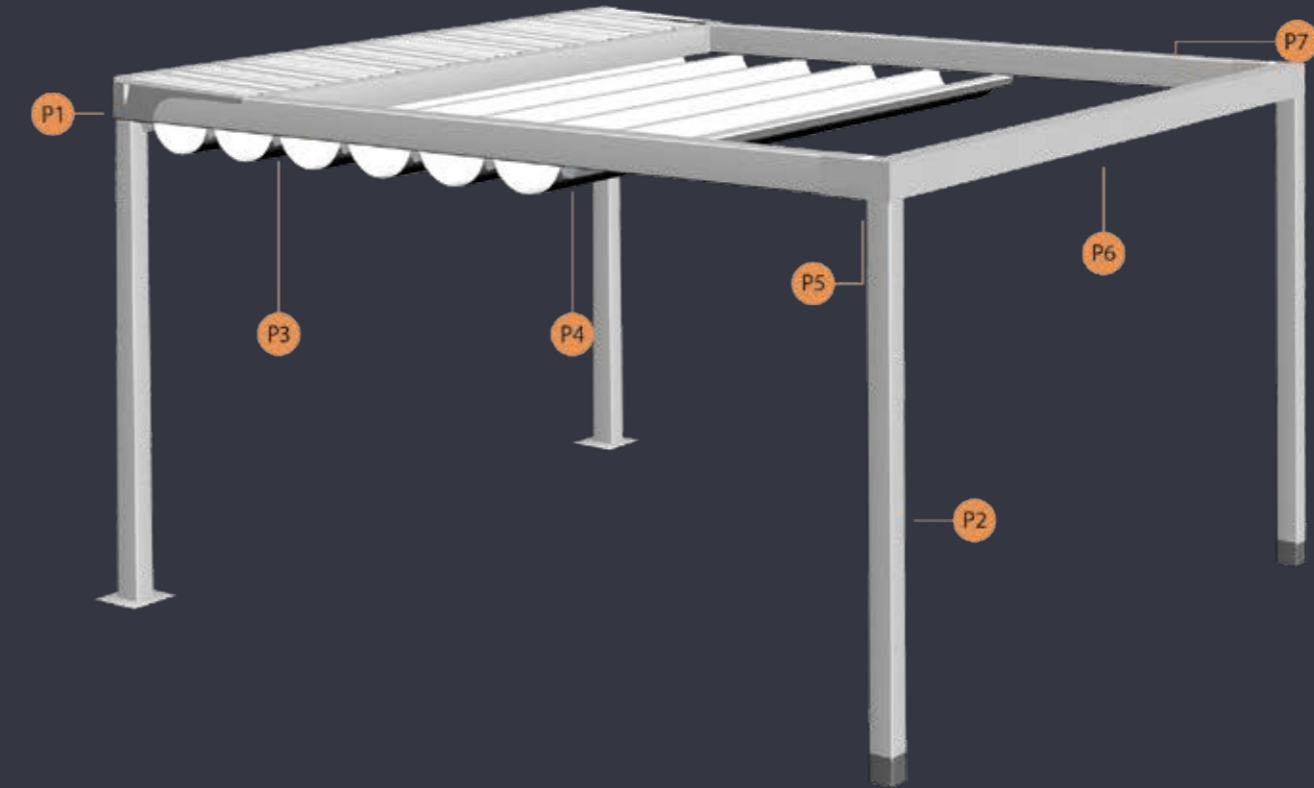
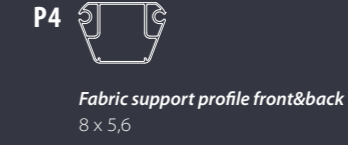



CORNAL

Embracing your home and your family, Coral is a beautiful addition to your abode.

The perpendicular roof and soft contours provide a welcome retreat from which you can watch the world go by!



CORNAL

ECO CURVED

Coral Eco is a soft sophisticated little addition to your home. Neat and tidy it nestles onto your outside space as if it's always been there.

Palmiye presents a wide range of ceiling covers, with a selection of colours, materials (such as PVC, fabric) patterns which are imported from Europe and U.S, with 5 years guaranty against fading and mould.

The entire drainage system is integrated into the structure and lighting systems can be adapted to the ceiling cover which moves together with it.

The Spot Lights or Linear Lights are installed on the aluminium profiles and can be controlled by a remote control or with a remote controlled dimmer function.

Each of our products is hand crafted and in itself unique, and from ceiling cover to construction material you can completely customize your products.

Palmiye is proud to present its own MyPalmiye App which has been designed specifically for Palmiye products and is available at Apple's App Store.

width	1300
projection	600
max rail centers	400

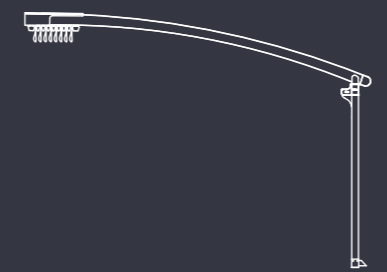

- P1**

 Wall joiner finish
- P2**

 Pillar
 8 x 8
- P3**

 Fabric support profile
 4,5 x 5,6
- P4**

 Fabric support profile front&back
 8 x 5,6
- P5**

 Gutter
 13 x 13
- P6**

 Front beam
 8 x 13
- P7**

 Rail end cap
 11,4 x 12

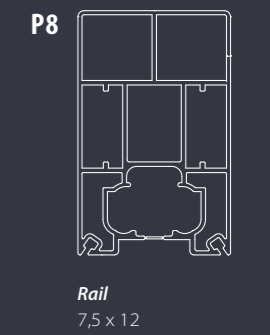
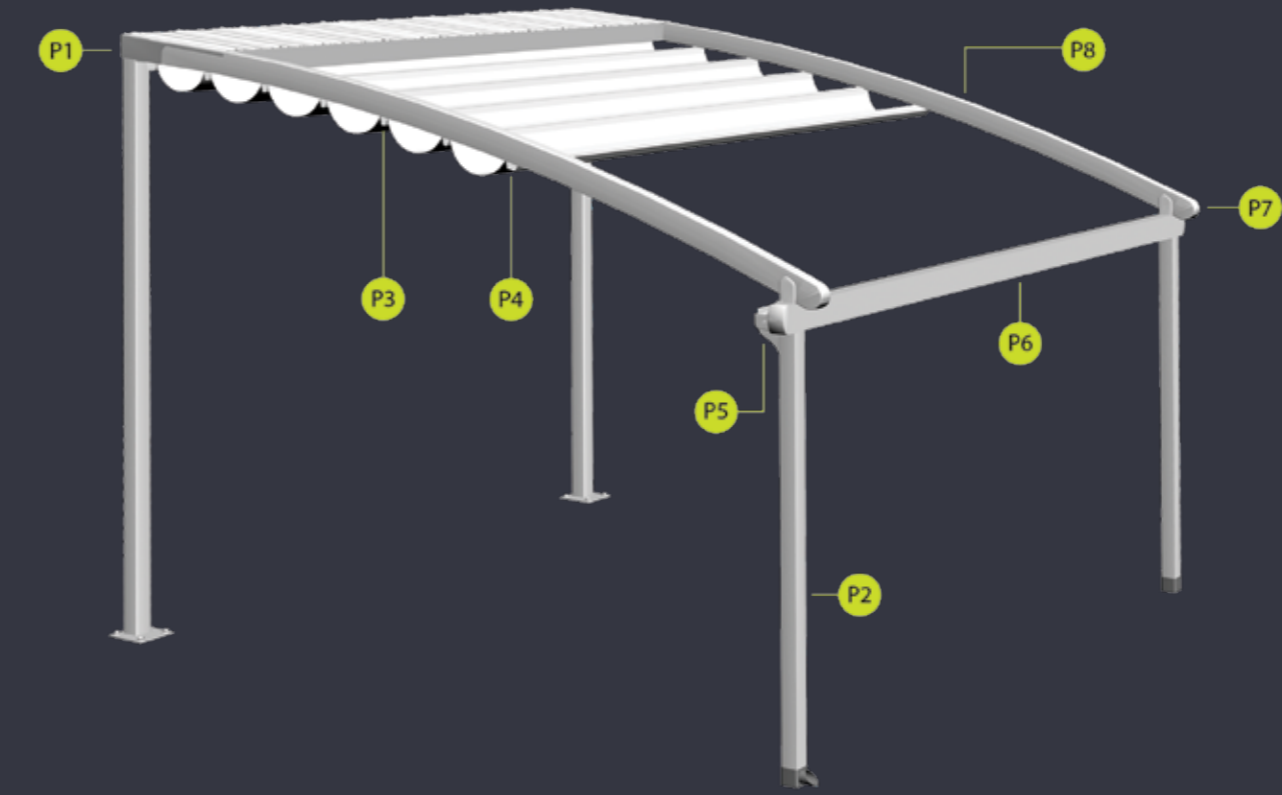



CORNAL

CURVED

Coral is a beautiful addition to your abode. The perpendicular roof and soft contours provide a welcome retreat from which you can watch the world go by.

The product is usable according to its User Manual in all-weather conditions and designed to be used in all four seasons. If desired the product can be made into retractable winter garden by closing the sides with different kinds of enclosures.

Palmiye presents a wide range of ceiling covers, with a selection of colours, materials (such as PVC, fabric) patterns which are imported from Europe and U.S, with 5 years guaranty against fading and mould.







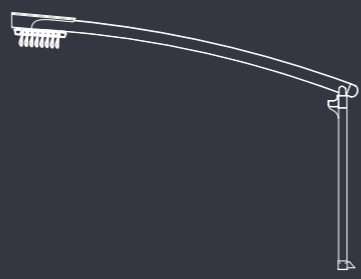

The entire drainage system is integrated into the structure and lighting systems can be adapted to the ceiling cover which moves together with it. The Spot Lights or Linear Lights are installed on the aluminium profiles and can be controlled by a remote control or with a remote controlled dimmer function.

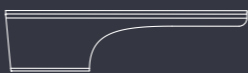
Each of our products is hand crafted and in itself unique, and from ceiling cover to construction material you can completely customize your products.

Palmiye is proud to present its own MyPalmiye App which has been designed specifically for Palmiye products and is available at Apple's App Store.

width	1300
projection	800
max rail centers	400

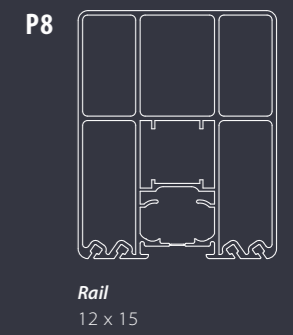

- P1**

 Wall joiner finish
- P2**

 Pillar
 10 x 10
- P3**

 Fabric support profile
 4,5 x 5,6
- P4**

 Fabric support profile front&back
 8 x 5,6
- P5**

 Gutter
 13 x 13
- P6**

 Front beam
 10 x 15
- P7/1**

 Rail end cap rounde
 11,3 x 15
- P7/2**

 Rail end cap square
 11,3 x 15





BRILLIANT

Simple and clean-cut in its design, Brilliant welcomes you and your friends with style and charisma. Experience the changing seasons from within the comfort of your own Brilliant space.



BRILLIANT

TILTED

Simple and clean-cut in its design. Brilliant welcomes you with its' continuous lines and designs. Experience the changing seasons from within the comfort of your own Brilliant space.

Palmiye presents a wide range of ceiling covers, with a selection of colours, materials (such as PVC, fabric) patterns which are imported from Europe and U.S, with 5 years guaranty against fading and mould.

Lighting systems can be adapted to the ceiling cover which moves together with it.

The Spot Lights or Linear Lights are installed on the aluminium profiles and can be controlled by a remote control or with a remote controlled dimmer function. Each of our products is hand crafted and in itself unique, and from ceiling cover to the construction material you can completely customize your products.

Palmiye is proud to present its own MyPalmiye App which has been designed specifically for Palmiye products and is available at Apple's App Store.

width	1300
projection	800
max rail centers	450

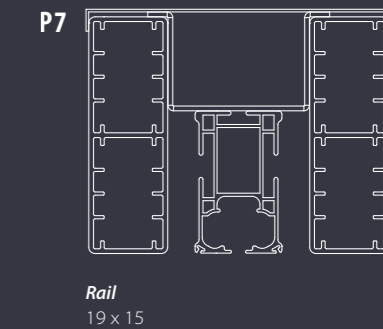
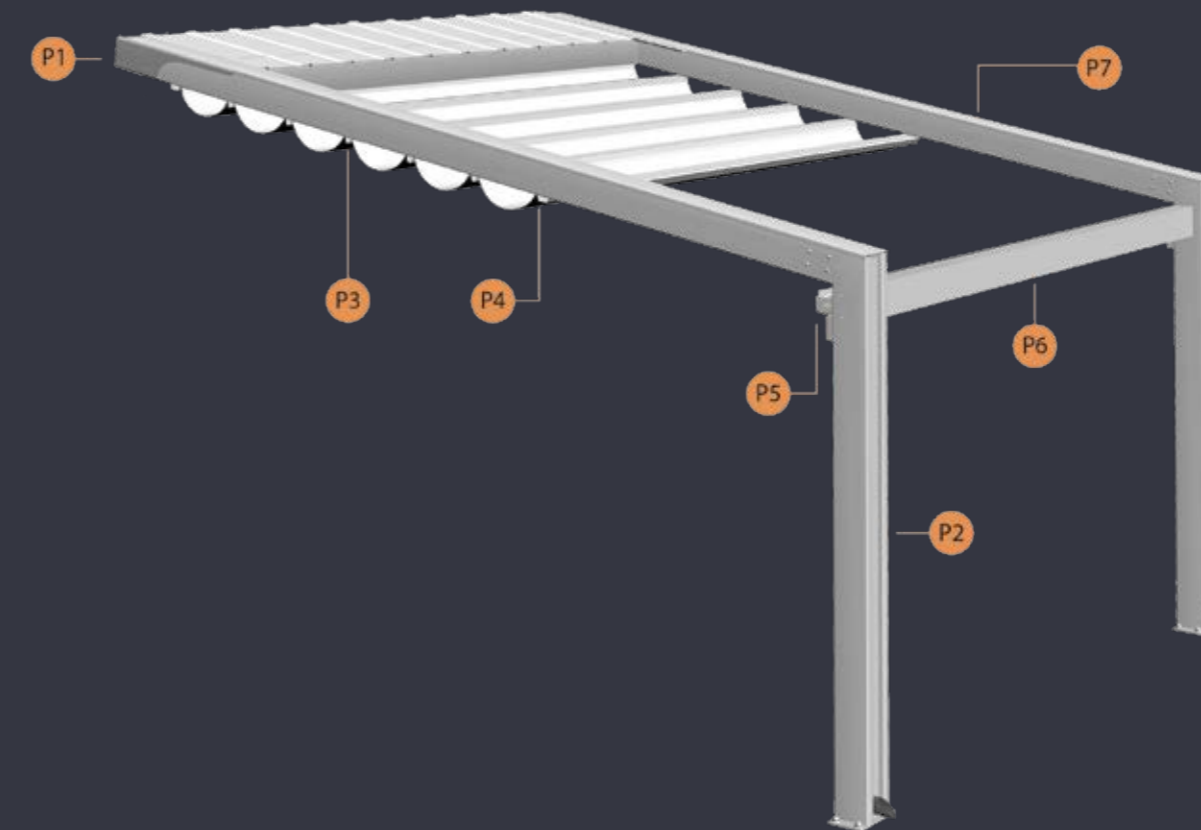
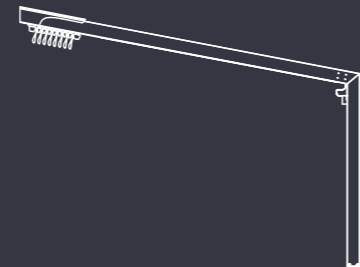

The freedom of endless horizons.



GALA

Specially designed to accommodate large numbers, this stylish construction provides the perfect setting to entertain your guests.

Spacious and stylish, Gala is the ultimate outdoor experience.



GALA

ECO DOUBLE TILTED

The streamline construction of Gala Eco is the ultimate party space! With its slender yet robust architecture you and your guests can literally 'raise the roof'!

Palmiye presents a wide range of ceiling covers, with a selection of colours, materials and patterns which are imported from Europe and U.S, with 5 years guaranty against fading and mould.

The entire drainage system is integrated into the structure and lighting systems can be adapted to the ceiling cover which moves together with it.

The Spot Lights or Linear Lights are installed on the aluminium profiles and can be controlled by a remote control or with a remote controlled dimmer function.

Each of our products is hand crafted and in itself unique, and from ceiling cover to the construction material you can completely customize your products.

Palmiye is proud to present its own MyPalmiye App which has been designed specifically for Palmiye products and is available at Apple's App Store.

width	1300
projection	1200
max rail centers	450

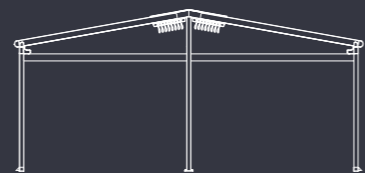

- P1**

 Wall joiner finish
- P2**

 Pillar
 8 x 8
- P3**

 Gutter
 13 x 13
- P4**

 Side beam
 8 x 13
- P5**

 Fabric support profile
 4,5 x 5,6
- P6**

 Fabric support profile front&back
 8 x 5,6
- P7**

 Front beam
 8 x 13
- P8**

 Rail end cap
 11,4 x 12

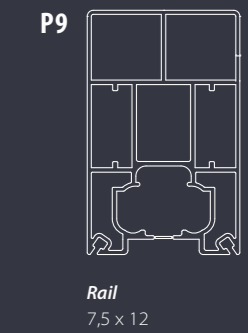
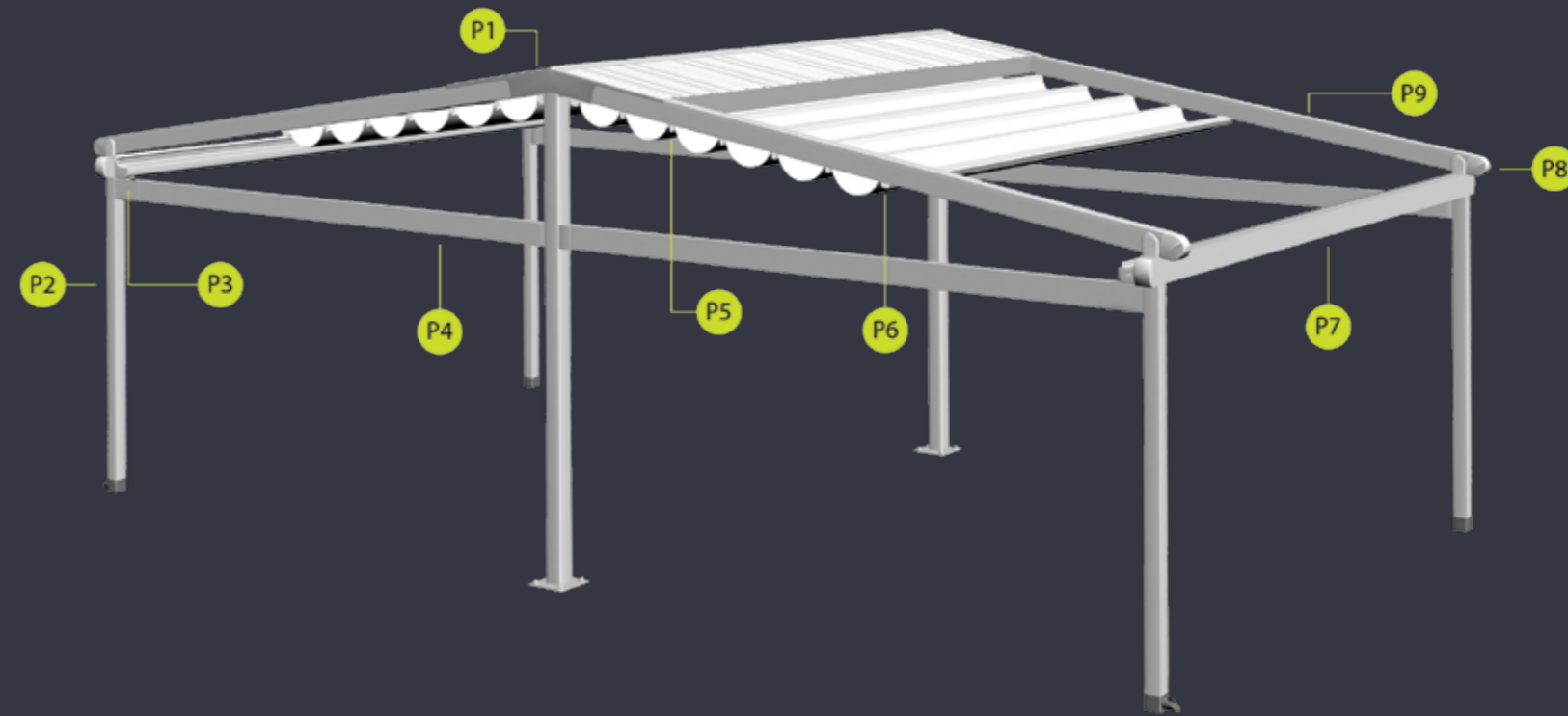



GALA

DOUBLE TILTED

Specially Designed to accommodate large numbers, this stylish construction provides the perfect setting to entertain your guests. Spacious and stylish Gala is the ultimate outdoor experience.

The product is usable according to its User Manual in all-weather conditions and designed to be used in all four seasons. If desired the product can be made into a retractable winter garden by closing the sides with different kinds of enclosures.

Palmiye presents a wide range of ceiling covers, with a selection of colours, materials and patterns which are imported from Europe and U.S, with 5 years guaranty against fading and mould.







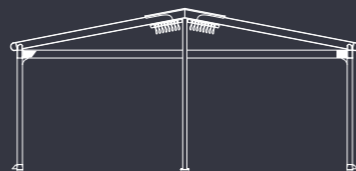

The entire drainage system is integrated into the structure and lighting systems can be adapted to the ceiling cover which moves together with it. The Spot Lights or Linear Lights are installed on the aluminium profiles and can be controlled by a remote control or with a remote controlled dimmer function.

Each of our products is hand crafted and in itself unique, and from ceiling cover to the construction material you can completely customize your products.

Palmiye is proud to present its own MyPalmiye App which has been designed specifically for Palmiye products and is available at Apple's App Store.

width	1300
projection	2000
max rail centers	450

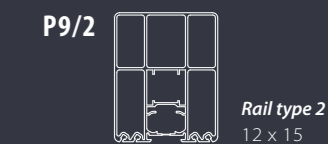
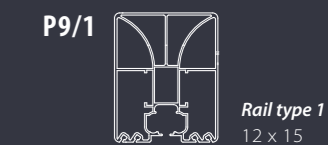
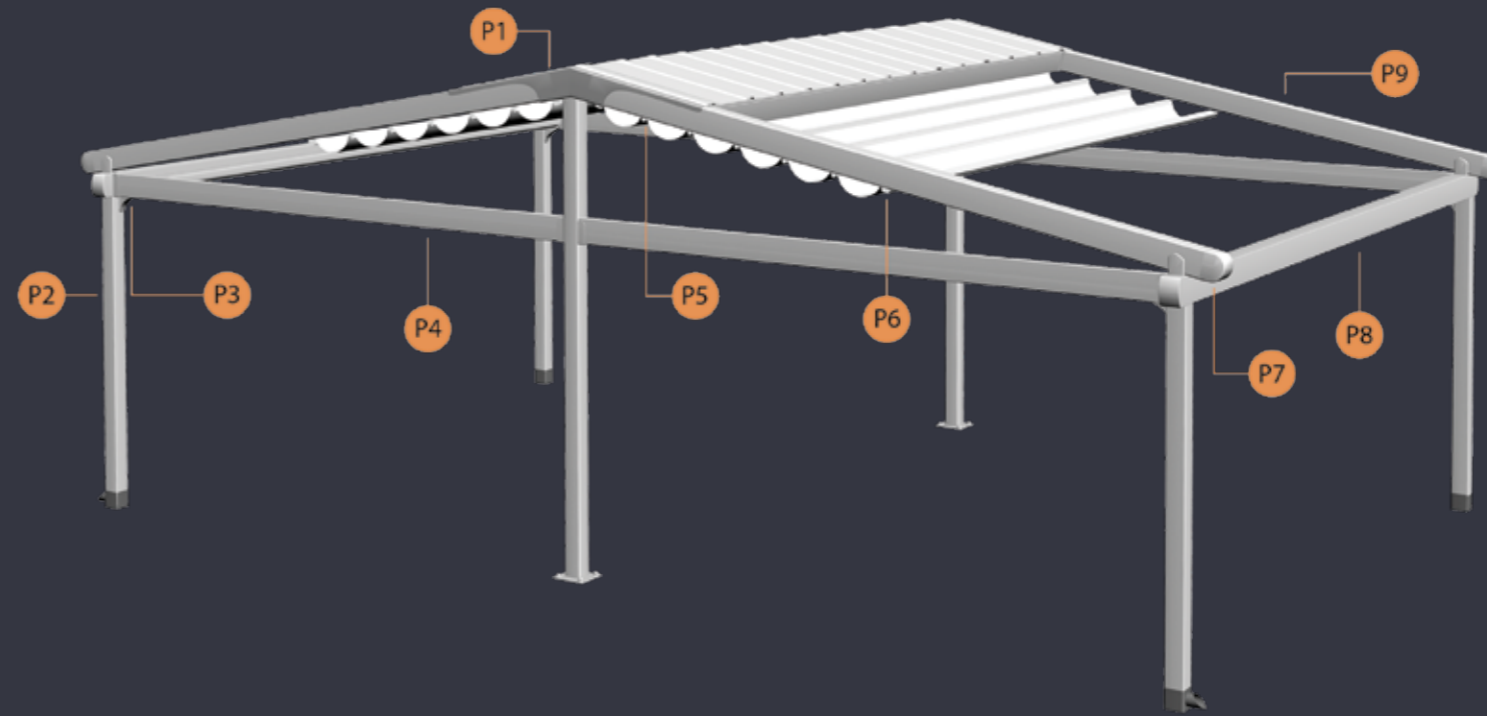

- P1**

 Wall joiner finish
- P2**

 Pillar
 10 x 10
- P3**

 Gutter
 13 x 13
- P4**

 Side beam
 10 x 15
- P5**

 Fabric support profile
 4,5 x 5,6
- P6**

 Fabric support profile front&back
 8 x 5,6
- P7/1**

 Rail end cap rounded
 11,3 x 15
- P7/2**

 Rail end cap square
 11,3 x 15
- P8**

 Front beam
 10 x 15





CROWN

This spacious design creates a relaxing atmosphere in which guests can enjoy their time to the max.

The soft contours of the design provide an intimate setting and ensure unforgettable memories.



CROWN

ECO CURVED SINGLE MOTOR

The intimate design of Crown Eco provides a welcoming area in which guests can retreat. The curvaceous architecture contributes to the cosiest of setting in all outdoor spaces. In this product the ceiling cover is retracting as one piece.

Palmiye presents a wide range of ceiling covers, with a selection of colours, materials and patterns which are imported from Europe and U.S, with 5 years guaranty against fading and mould.

The entire drainage system is integrated into the structure and lighting systems can be adapted to the ceiling cover which moves together with it.

The Spot Lights or Linear Lights are installed on the aluminium profiles and can be controlled by a remote control or with a remote controlled dimmer function.

Each of our products is hand crafted and in itself unique, and from ceiling cover to the construction material you can completely customize your products.

Palmiye is proud to present its own MyPalmiye App which has been designed specifically for Palmiye products and is available at Apple's App Store.

width	1300
projection	600
max rail centers	350

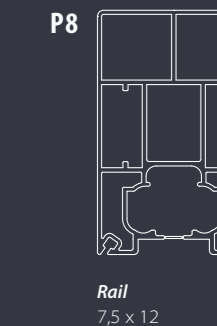
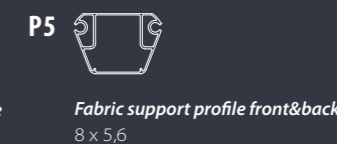
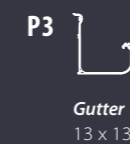
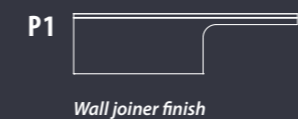
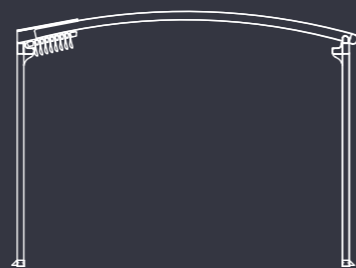

CROWN

CURVED SINGLE MOTOR

This spacious design creates a relaxing atmosphere in which guests can enjoy their time to max. The soft contours of the design provide an intimate setting and ensure unforgettable memories. In this product the ceiling cover is retracting as one piece.

The product is usable according to its User Manual in all-weather conditions and designed to be used in all four seasons. If desired the product can be made into retractable winter garden by closing the sides with different kinds of enclosures.

Palmiye presents a wide range of ceiling covers, with a selection of colours, materials and patterns which are imported from Europe and U.S, with 5 years guaranty against fading and mould.

The entire drainage system is integrated into the structure and lighting systems can be adapted to the ceiling cover which moves together with it.

The Spot Lights or Linear Lights are installed on the aluminium profiles and can be controlled by a remote control or with a remote controlled dimmer function. Each of our products is hand crafted and in itself unique, and from ceiling cover to the construction material you can completely customize your products.

width	1300
projection	800
max rail centers	350

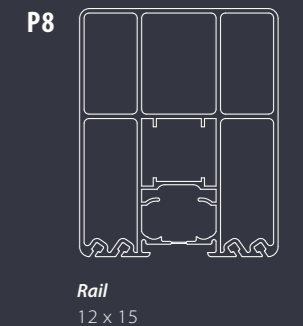
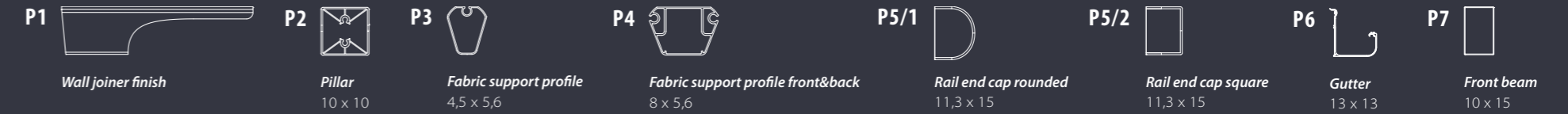
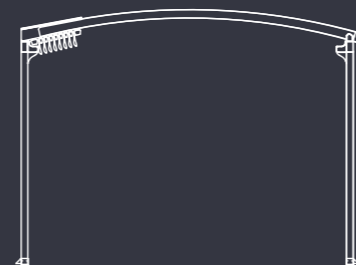

Rail
12 x 15



CROWN

ECO CURVED DOUBLE MOTOR

The intimate design of Crown Eco provides a welcoming area in which guests can retreat. The curvaceous architecture contributes to the cosiest of setting in all outdoor spaces. In this product the ceiling cover is retracting as two pieces.

Palmiye presents a wide range of ceiling covers, with a selection of colours, materials and patterns which are imported from Europe and U.S, with 5 years guaranty against fading and mould.

The entire drainage system is integrated into the structure and lighting systems can be adapted to the ceiling cover which moves together with it.

The Spot Lights or Linear Lights are installed on the aluminium profiles and can be controlled by a remote control or with a remote controlled dimmer function.

Each of our products is hand crafted and in itself unique, and from ceiling cover to the construction material you can completely customize your products.

Palmiye is proud to present its own MyPalmiye App which has been designed specifically for Palmiye products and is available at Apple's App Store.

width	1300
projection	1200
max rail centers	400

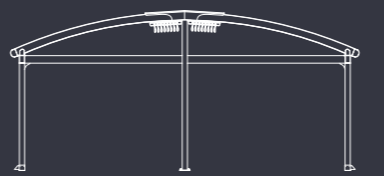

- P1 

Wall joiner finish
- P2 

Pillar
8 x 8
- P3 

Gutter
13 x 13
- P4 

Side beam
8 x 13
- P5 

Fabric support profile
4,5 x 5,6
- P6 

Fabric support profile front&back
8 x 5,6
- P7 

Front beam
8 x 13
- P8 

Rail end cap
11,4 x 12

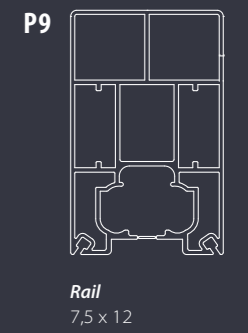
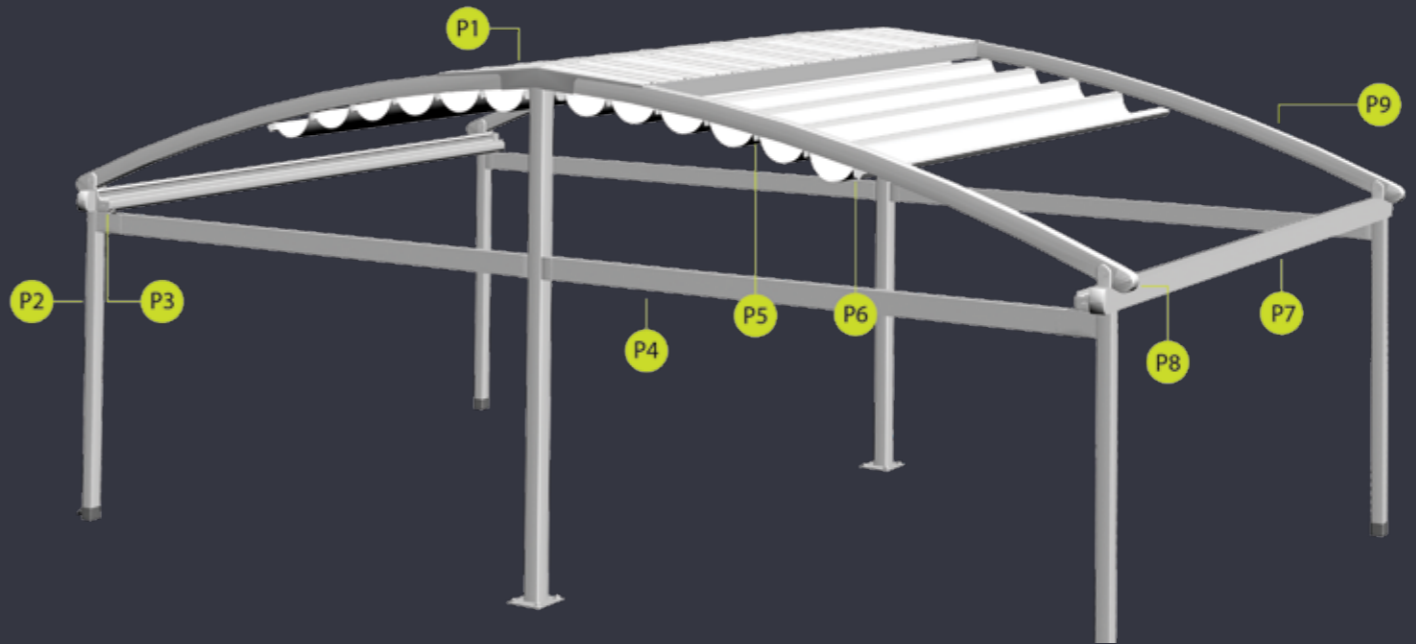



CROWN

CURVED DOUBLE MOTOR

This spacious design creates a relaxing atmosphere in which guests can enjoy their time to max. The soft contours of the design provide an intimate setting and ensure unforgettable memories. In this product the ceiling cover is retracting as two pieces.

The product is usable according to its User Manual in all-weather conditions and designed to be used in all four seasons. If desired the product can be made into retractable winter garden by closing the sides with different kinds of enclosures.







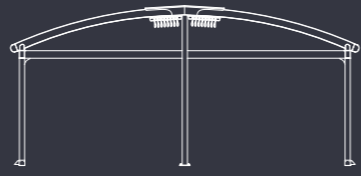

Palmiye presents a wide range of ceiling covers, with a selection of colours, materials and patterns which are imported from Europe and U.S, with 5 years guaranty against fading and mould.

The entire drainage system is integrated into the structure and lighting systems can be adapted to the ceiling cover which moves together with it. The Spot Lights or Linear Lights are installed on the aluminium profiles and can be controlled by a remote control or with a remote controlled dimmer function.

Each of our products is hand crafted and in itself unique, and from ceiling cover to the construction material you can completely customize your products.

width	1300
projection	1600
max rail centers	400



- P1** 
 Wall joiner finish
- P2** 
 Pillar
 10 x 10
- P3** 
 Gutter
 13 x 13
- P4** 
 Side beam
 10 x 15
- P5** 
 Fabric support profile
 4,5 x 5,6
- P6** 
 Fabric support profile front&back
 8 x 5,6
- P7/1** 
 Rail end cap rounded
 11,3 x 15
- P7/2** 
 Rail end cap square
 11,3 x 15
- P8** 
 Front beam
 10 x 15

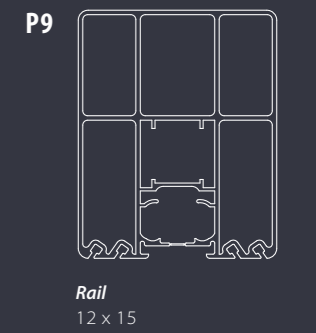
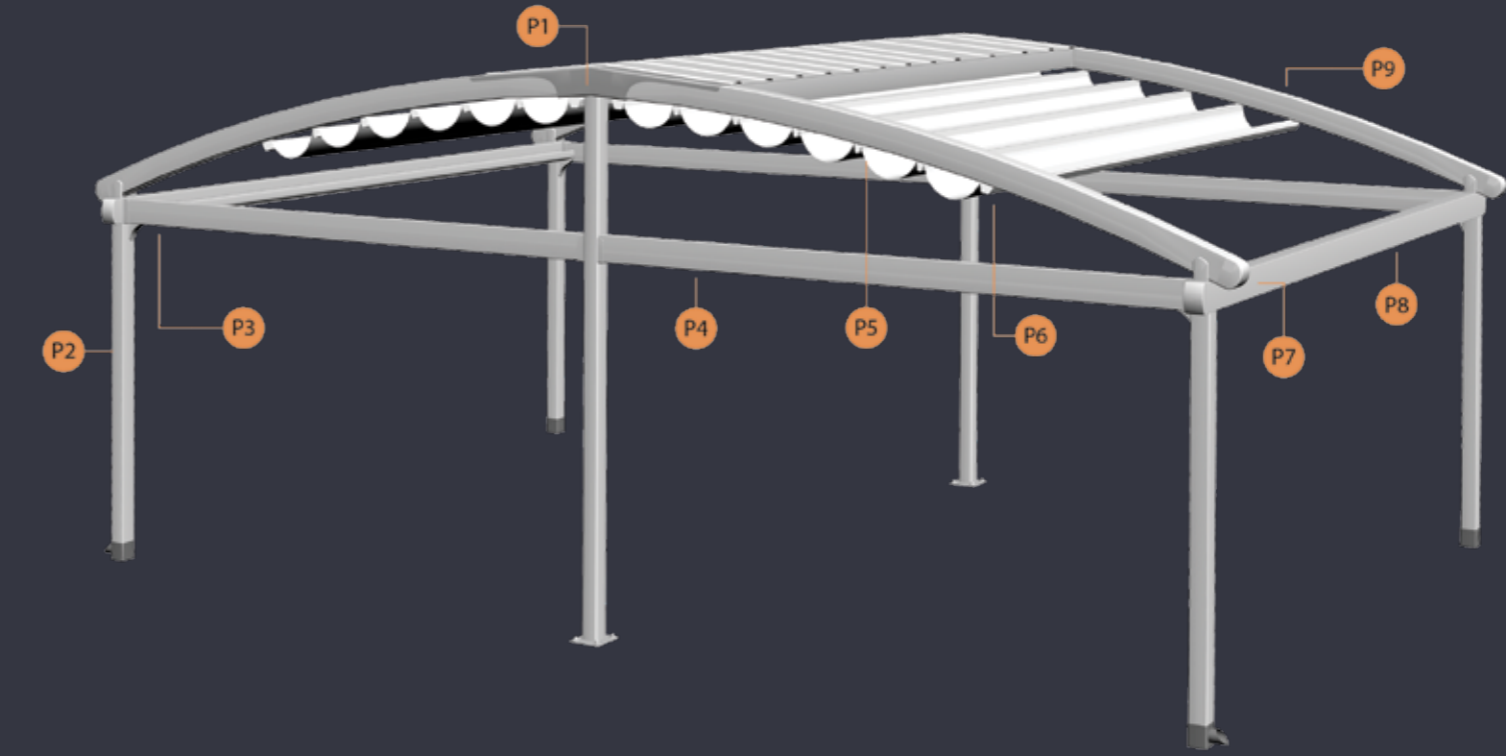



PAVILION

Delightfully male in appearance, this chiselled design provides ultimate garden luxury.

With its angular details and strong features, Pavilion is perfect for getting the most out of your outdoor living area throughout the year.



PAVILION

TILTED

It's a stylish aluminium retractable roof system. With its angular details and strong features Pavilion has a tilted ceiling. Perfect for getting the most out of your outdoor living area throughout the year.

The product is usable according to its User Manual in all-weather conditions and designed to be used in all four seasons. If desired the product can be made into retractable winter garden by closing the sides with different kinds of enclosures.

Palmiye presents a wide range of ceiling covers, with a selection of colours, materials and patterns which are imported from Europe and U.S, with 5 years guaranty against fading and mould.

The entire drainage system is integrated into the structure and lighting systems can be adapted to the ceiling cover which moves together with it.

The Spot Lights or Linear Lights are installed on the aluminium profiles and can be controlled by a remote control or with a remote controlled dimmer function.

Each of our products is hand crafted and in itself unique, and from ceiling cover to the construction material you can completely customize your products.

Palmiye is proud to present its own MyPalmiye App which has been designed specifically for Palmiye products and is available at Apple's App Store.

width	1300
projection	800
max rail centers	450

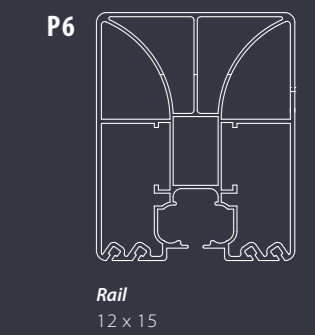
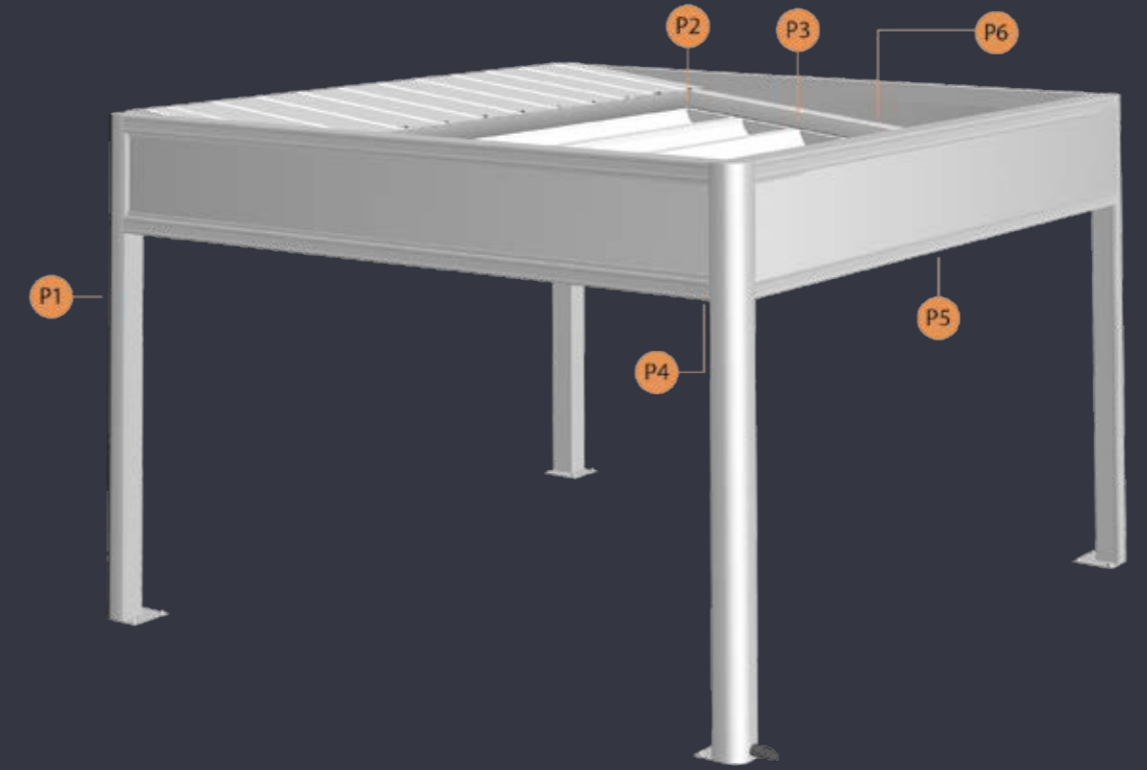
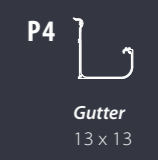
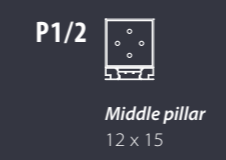
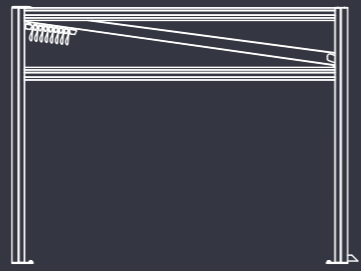



PAVILION

FLAT

It's a stylish aluminium retractable roof system. With its angular details and strong features Pavilion has a flat ceiling. Palmiye with its unique techniques can drain the water from a flat ceiling cover. Perfect for getting the most out of your outdoor living area throughout the year. The product is usable according to its User Manual in all-weather conditions and designed to be used in all four seasons.

If desired the product can be made into retractable winter garden by closing the sides with different kinds of enclosures.

Palmiye presents a wide range of ceiling covers, with a selection of colours, materials and patterns which are imported from Europe and U.S, with 5 years guaranty against fading and mould.

The entire drainage system is integrated into the structure and lighting systems can be adapted to the ceiling cover which moves together with it.

The Spot Lights or Linear Lights are installed on the aluminium profiles and can be controlled by a remote control or with a remote controlled dimmer function.

Palmiye is proud to present its own MyPalmiye App which has been designed specifically for Palmiye products and is available at Apple's App Store.

width	1300
projection	800
max rail centers	450

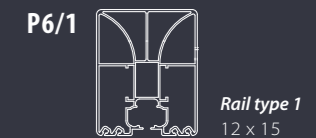
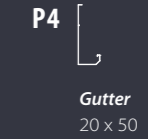
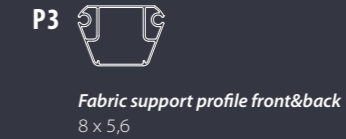
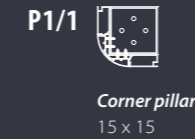
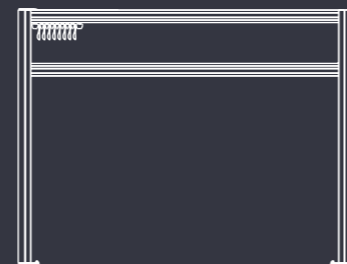



PAVILION

CURVED

It's a stylish aluminium retractable roof system. With its angular details and strong features Pavilion has a curved ceiling. Perfect for getting the most out of your outdoor living area throughout the year.

The product is usable according to its User Manual in all-weather conditions and designed to be used in all four seasons. If desired the product can be made into retractable winter garden by closing the sides with different kinds of enclosures.

Palmiye presents a wide range of ceiling covers, with a selection of colours, materials and patterns which are imported from Europe and U.S, with 5 years guaranty against fading and mould.

The entire drainage system is integrated into the structure and lighting systems can be adapted to the ceiling cover which moves together with it. The Spot Lights or Linear Lights are installed on the aluminium profiles and can be controlled by a remote control or with a remote controlled dimmer function.

Palmiye is proud to present its own MyPalmiye App which has been designed specifically for Palmiye products and is available at Apple's App Store.

width	1300
projection	800
max rail centers	350

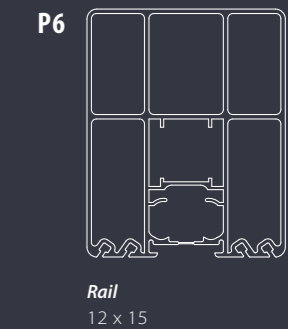
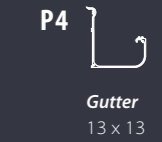
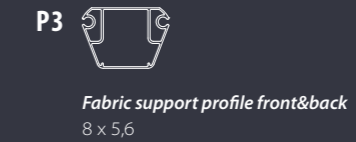
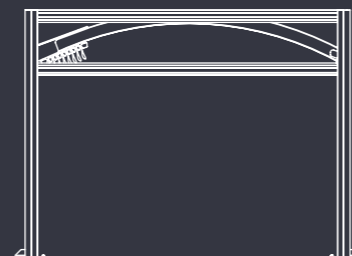



Hazy days with the touch of a Coral caress.



PANORAMA

Panorama is remarkable in that it has no front support at all, thus allowing you to enjoy unbroken views.

Straight in design, Panorama is an unobtrusive way to enjoy the world in which you live.



PANORAMA

ECO TILTED SUSPENDED

Minimalistic Panorama Eco is so minimalistic it is sometimes easy to forget its very existence! Inconspicuous and unassuming its gentle protection is a delight in every way!

Palmiye presents a wide range of ceiling covers, with a selection of colours, materials and patterns which are imported from Europe and U.S, with 5 years guaranty against fading and mould.

Lighting systems can be adapted to the ceiling cover which moves together with it.

The Spot Lights or Linear Lights are installed on the aluminium profiles and can be controlled by a remote control or with a remote controlled dimmer function.

Each of our products is hand crafted and in itself unique, and from ceiling cover to the construction material you can completely customize your products.

Palmiye is proud to present its own MyPalmiye App which has been designed specifically for Palmiye products and is available at Apple's App Store.

width	1300
projection	600
max rail centers	450

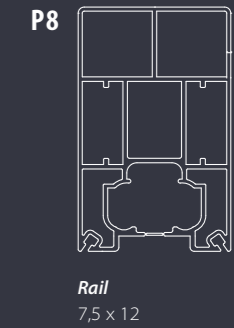
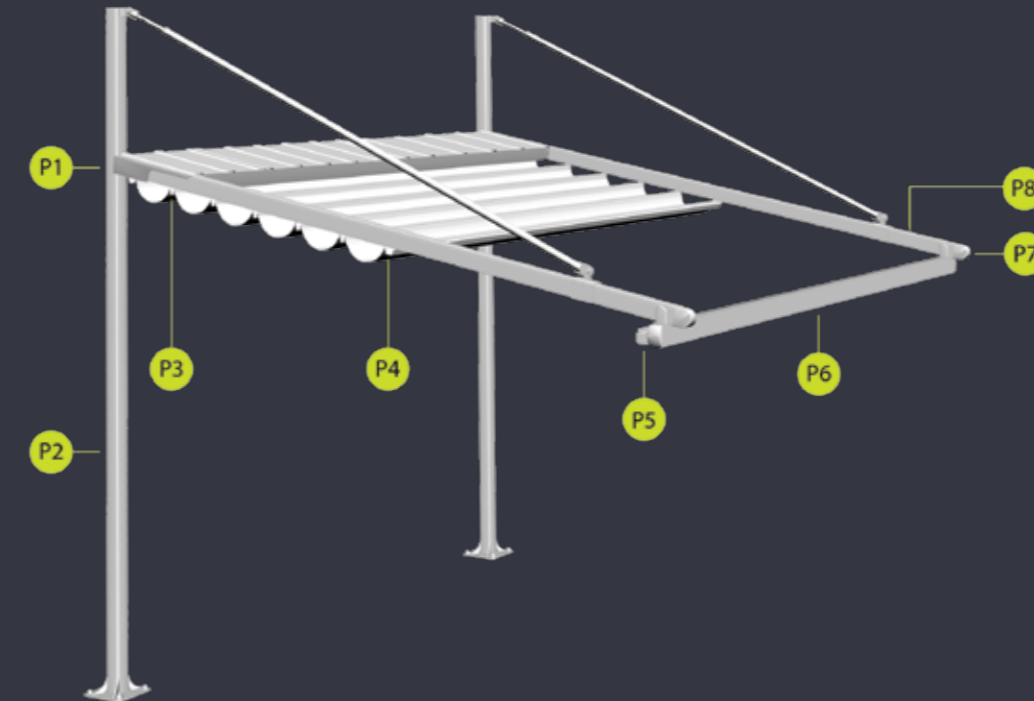
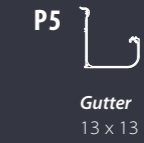
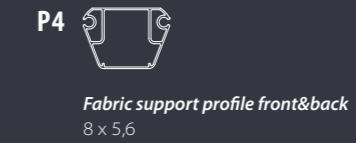
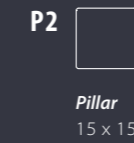
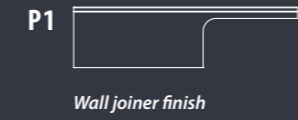
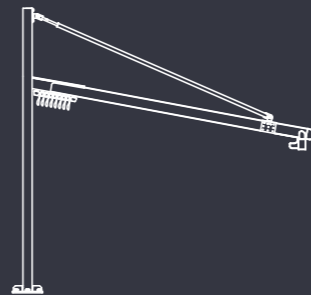



PANORAMA

TILTED SUSPENDED

Panorama is remarkable is that it has no front support at all, thus allowing you to enjoy unbroken views. With its modern design and the buttress, Panorama will provide you an elegant and stylish atmosphere.

The product is usable according to its User Manual in all-weather conditions and designed to be used in all four seasons.

Palmiye presents a wide range of ceiling covers, with a selection of colours, materials and patterns which are imported from Europe and U.S, with 5 years guaranty against fading and mould.

Lighting systems can be adapted to the ceiling cover which moves together with it.

The Spot Lights or Linear Lights are installed on the aluminium profiles and can be controlled by a remote control or with a remote controlled dimmer function.

Each of our products is hand crafted and in itself unique, and from ceiling cover to the construction material you can completely customize your products.

Palmiye is proud to present its own MyPalmiye App which has been designed specifically for Palmiye products and is available at Apple's App Store.

width	1300
projection	600
max rail centers	450

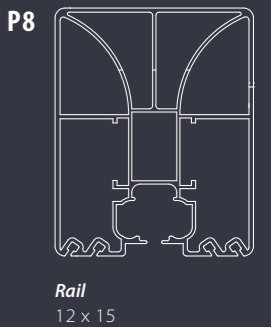
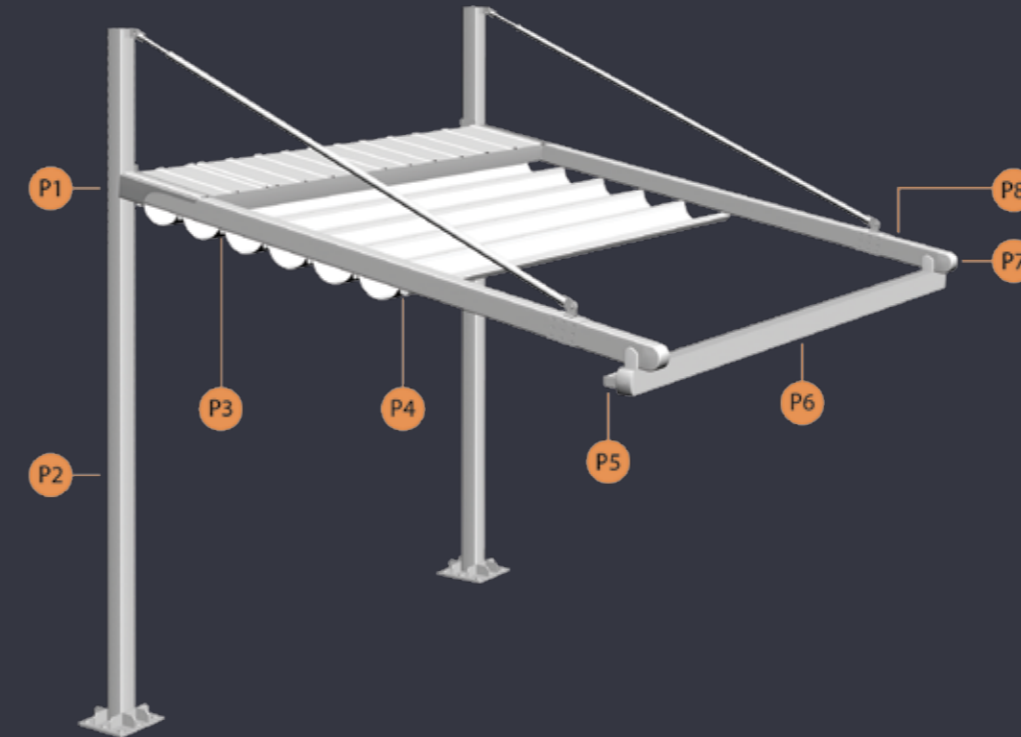
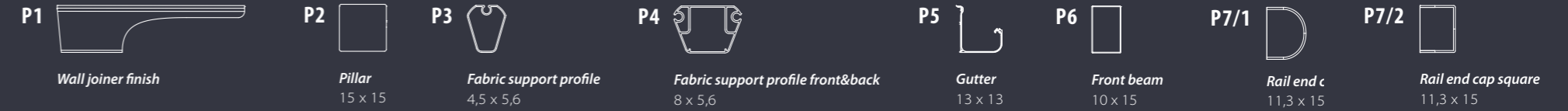
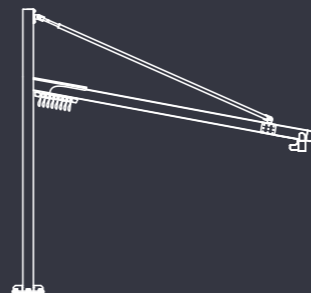



PANORAMA

TILTED BUTTRESS

Panorama is remarkable is that it has no front support at all, thus allowing you to enjoy unbroken views. With its modern design and the tension pipes, Four Seasons Panorama will provide you an elegant and stylish atmosphere.

The product is usable according to its User Manual in all-weather conditions and designed to be used in all four seasons.

Palmiye presents a wide range of ceiling covers, with a selection of colours, materials and patterns which are imported from Europe and U.S, with 5 years guaranty against fading and mould.

Lighting systems can be adapted to the ceiling cover which moves together with it.

The Spot Lights or Linear Lights are installed on the aluminium profiles and can be controlled by a remote control or with a remote controlled dimmer function.

Each of our products is hand crafted and in itself unique, and from ceiling cover to the construction material you can completely customize your products.

Palmiye is proud to present its own MyPalmiye App which has been designed specifically for Palmiye products and is available at Apple's App Store.

width	450
projection	400
max rail centers	450

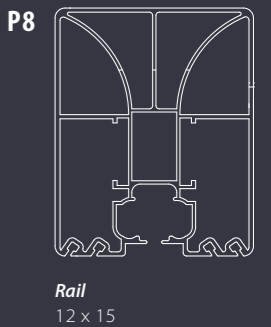
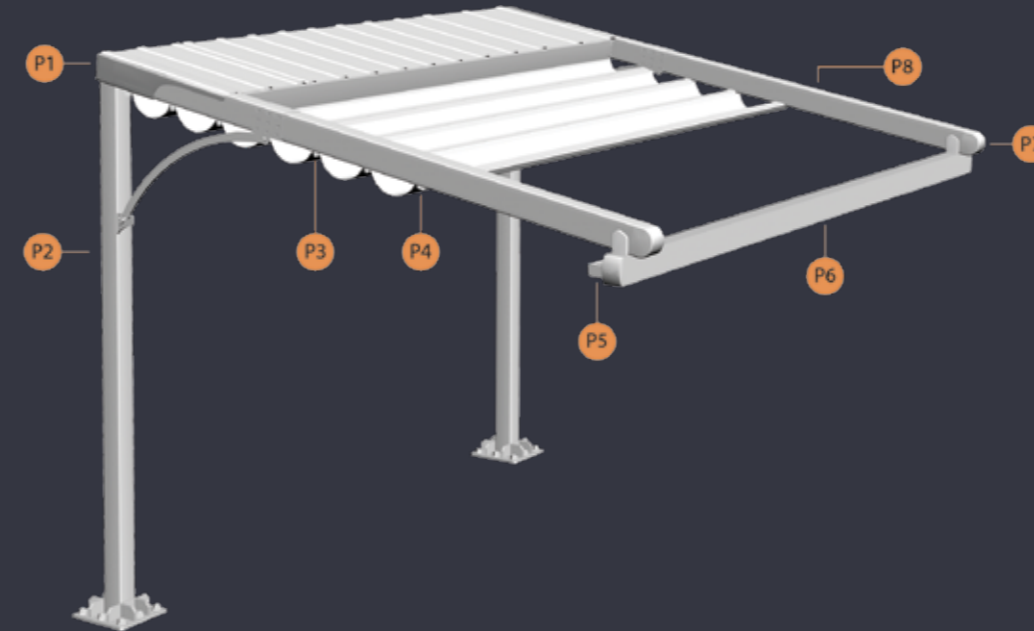
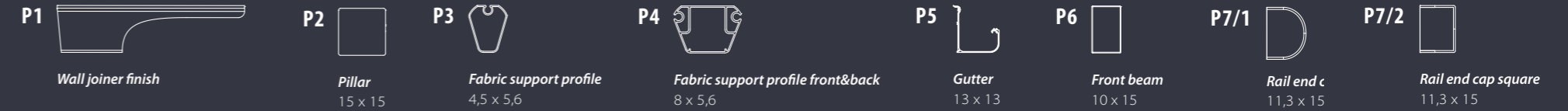
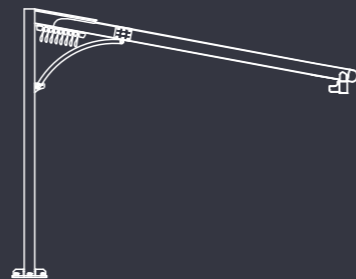



ALBATROS

Albatros is remarkable in that it has no front support at all, thus allowing you to enjoy unbroken views.

Gently arched in design, Albatros is an unobtrusive way to enjoy the world in which you live.



ALBATROS

ECO CURVED SUSPENDED

As light as the wing of a bird. Albatros Eco exists above you, with its slender arches quietly protecting from the elements.

Palmiye presents a wide range of ceiling covers, with a selection of colours, materials and patterns which are imported from Europe and U.S, with 5 years guaranty against fading and mould.

Lighting systems can be adapted to the ceiling cover which moves together with it. The Spot Lights or Linear Lights are installed on the aluminium profiles and can be controlled by a remote control or with a remote controlled dimmer function.

Each of our products is hand crafted and in itself unique, and from ceiling cover to the construction material you can completely customize your products.

Palmiye is proud to present its own MyPalmiye App which has been designed specifically for Palmiye products and is available at Apple's App Store.

width	1300
projection	600
max rail centers	400

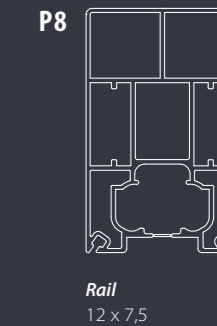
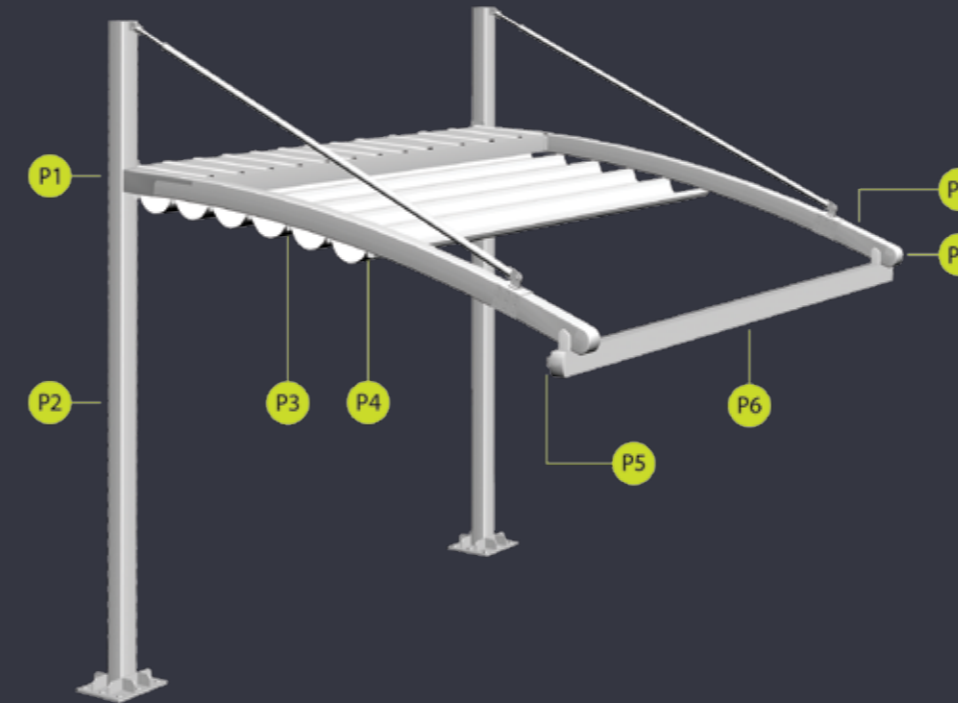
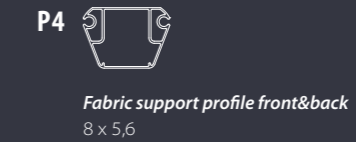
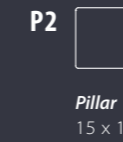
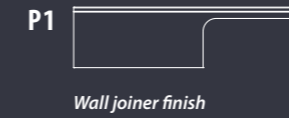
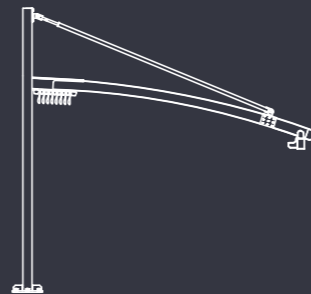



ALBATROS

CURVED SUSPENDED

Majestic yet graceful Albatros silently looks down, unobtrusively watching those who gather beneath it. Perfect for those who want to enjoy magnificent views in an unbroken yet protected manner!

Palmiye presents a wide range of ceiling covers, with a selection of colours, materials and patterns which are imported from Europe and U.S, with 5 years warranty against fading and mould.

Lighting systems can be adapted to the ceiling cover which moves together with it.

The Spot Lights or Linear Lights are installed on the aluminium profiles and can be controlled by a remote control or with a remote controlled dimmer function.

Each of our products is hand crafted and in itself unique, and from ceiling cover to the construction material you can completely customize your products.

Palmiye is proud to present its own MyPalmiye App which has been designed specifically for Palmiye products and is available at Apple's App Store.

width	1300
projection	600
max rail centers	400

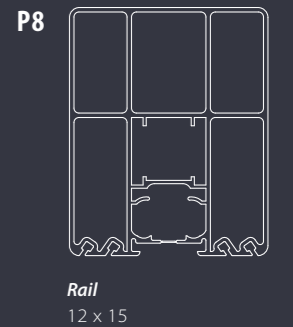
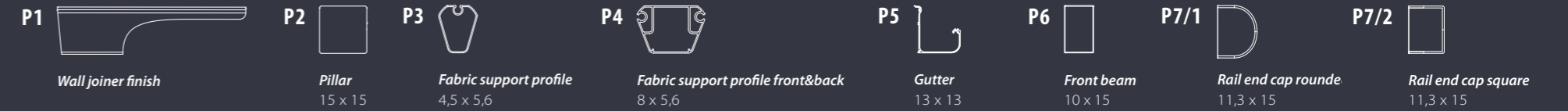
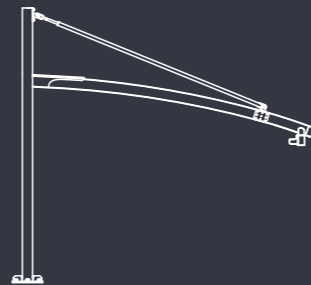



ALBATROS

CURVED BUTTRESS

Majestic yet graceful Albatros silently looks down, unobtrusively watching those who gather beneath it. Perfect for those who want to enjoy magnificent views in an unbroken yet protected manner! With its modern design and the buttress, Albatros will provide you an elegant and stylish atmosphere.

Palmiye presents a wide range of ceiling covers, with a selection of colours, materials and patterns which are imported from Europe and U.S, with 5 years guaranty against fading and mould.

Lighting systems can be adapted to the ceiling cover which moves together with it. The Spot Lights or Linear Lights are installed on the aluminium profiles and can be controlled by a remote control or with a remote controlled dimmer function.

Each of our products is hand crafted and in itself unique, and from ceiling cover to the construction material you can completely customize your products.

Palmiye is proud to present its own MyPalmiye App which has been designed specifically for Palmiye products and is available at Apple's App Store.

width	400
projection	400
max rail centers	400

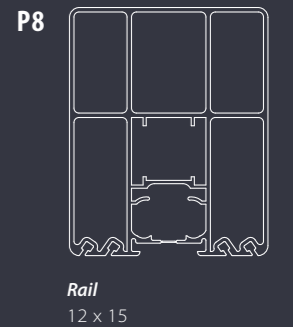
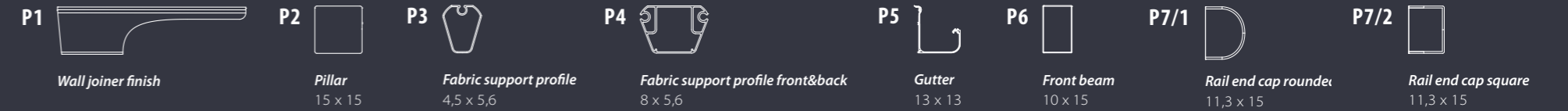
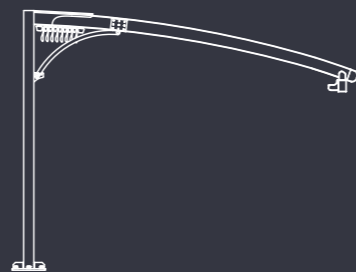

Incomparable space and majesty.





BRIDGE

An architectural beauty, this free-standing product sets you apart from other establishments, attracting attention and enabling your customers to get the most from their outdoor experience.



BRIDGE

ECO CURVED

Bridge Eco is an extraordinary piece of architecture! Slim line and slender the charismatic design is sure to attract the attention of all who see it!

Palmiye presents a wide range of ceiling covers, with a selection of colours, materials and patterns which are imported from Europe and U.S, with 5 years guaranty against fading and mould.

Lighting systems can be adapted to the ceiling cover which moves together with it.

The Spot Lights or Linear Lights are installed on the aluminium profiles and can be controlled by a remote control or with a remote controlled dimmer function.

Each of our products is hand crafted and in itself unique, and from ceiling cover to the construction material you can completely customize your products.

Palmiye is proud to present its own MyPalmiye App which has been designed specifically for Palmiye products and is available at Apple's App Store.

width	1300
projection	1200
max rail centers	400

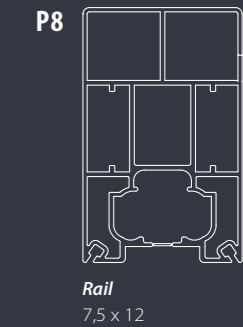
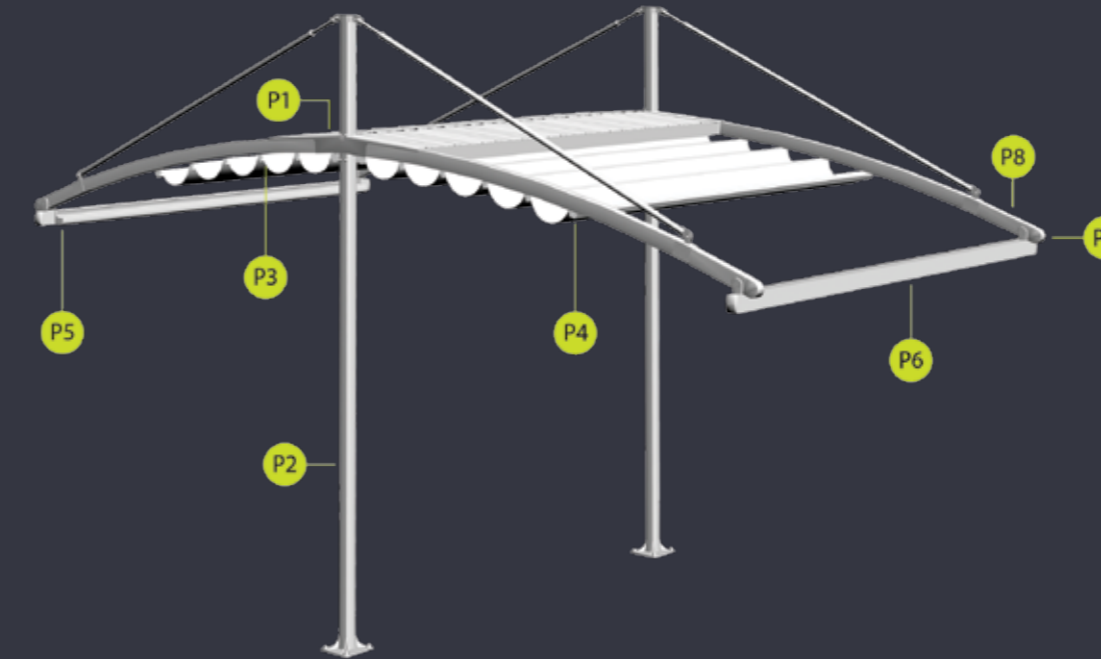
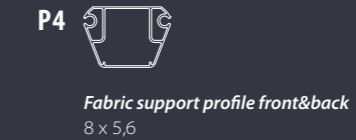
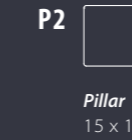
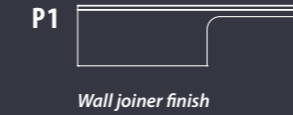
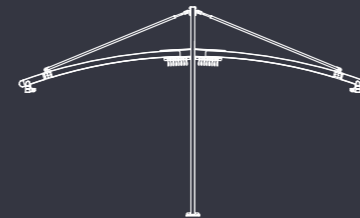



BRIDGE

CURVED

An architectural beauty this free standing product sets you apart from other establishments, attracting attention and enabling your customers to get the most from their outdoor experience.

The product is usable according to its User Manual in all-weather conditions and designed to be used in all four seasons.

Palmiye presents a wide range of ceiling covers, with a selection of colours, materials and patterns which are imported from Europe and U.S, with 5 years guaranty against fading and mould.

Lighting systems can be adapted to the ceiling cover which moves together with it.

The Spot Lights or Linear Lights are installed on the aluminium profiles and can be controlled by a remote control or with a remote controlled dimmer function.

Each of our products is hand crafted and in itself unique, and from ceiling cover to the construction material you can completely customize your products.

Palmiye is proud to present its own MyPalmiye App which has been designed specifically for Palmiye products and is available at Apple's App Store.

width	1300
projection	1200
max rail centers	400

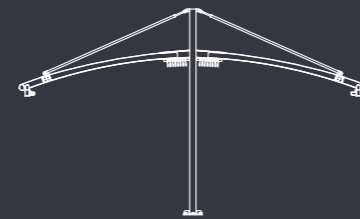



- P1 

Wall joiner finish
- P2 

Pillar
15 x 15
- P3 

Fabric support profile
4,5 x 5,6
- P4 

Fabric support profile front&back
8 x 5,6
- P5 

Gutter
13 x 13
- P6 

Front beam
10 x 15
- P7/1 

Rail end cap rounde
11,3 x 15
- P7/2 

Rail end cap square
11,3 x 15

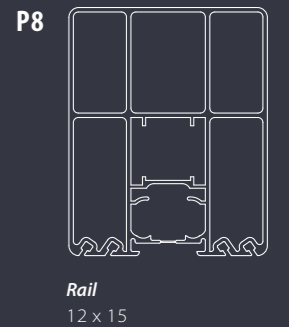
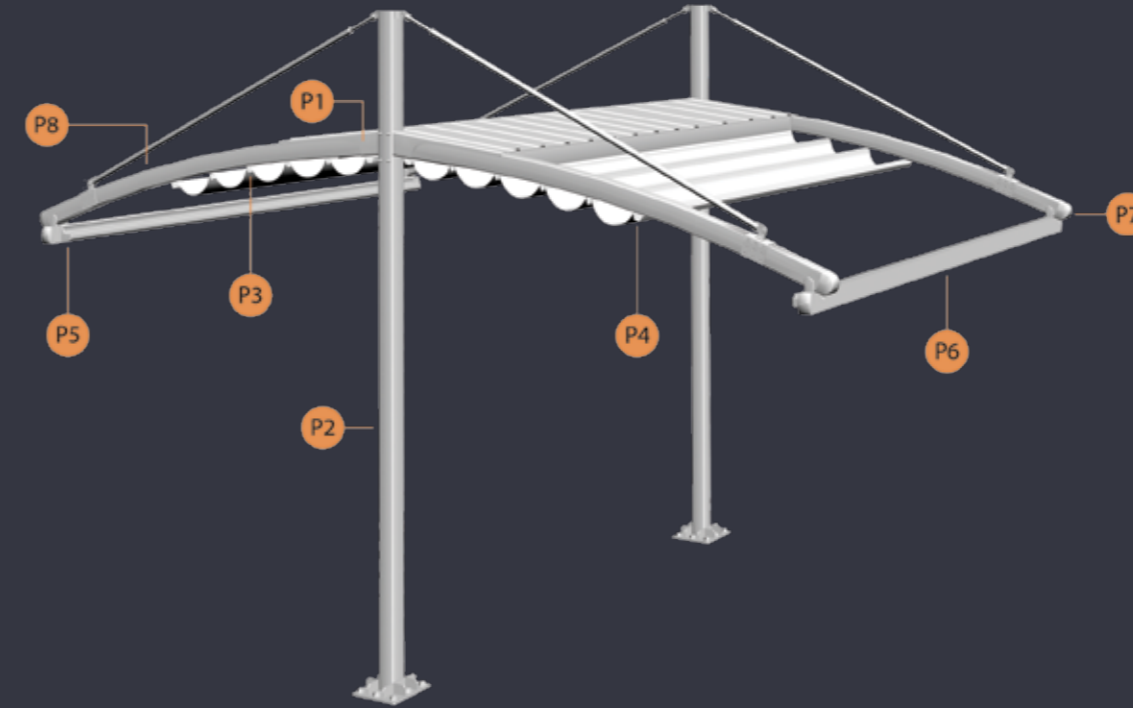



MARIN

This elegant product is free standing and is a stylish way to enlarge your outdoor living space.

The eye-catching nautical design creates a welcoming atmosphere and ensures that you make the best out of your area.



MARIN

ECO DOUBLE TILTED

Marine Eco is a tastefully practical product. With minimalistic, light-weight details it can be moved easily around to provide you with exactly what you need.

Palmiye presents a wide range of ceiling covers, with a selection of colours, materials and patterns which are imported from Europe and U.S, with 5 years guaranty against fading and mould.

Lighting systems can be adapted to the ceiling cover which moves together with it. The Spot Lights or Linear Lights

are installed on the aluminium profiles and can be controlled by a remote control or with a remote controlled dimmer function.

Each of our products is hand crafted and in itself unique, and from ceiling cover to the construction material you can completely customize your products.

width	1300
projection	1200
max rail centers	450

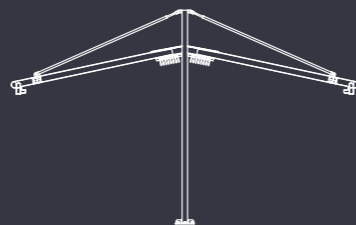

- P1**

 Wall joiner finish
- P2**

 Pillar
 15 x 15
- P3**

 Fabric support profile
 4,5 x 5,6
- P4**

 Fabric support profile front&back
 8 x 5,6
- P5**

 Gutter
 13 x 13
- P6**

 Front beam
 8 x 13
- P7**

 Rail end cap
 11,4 x 12

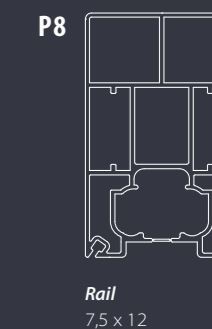
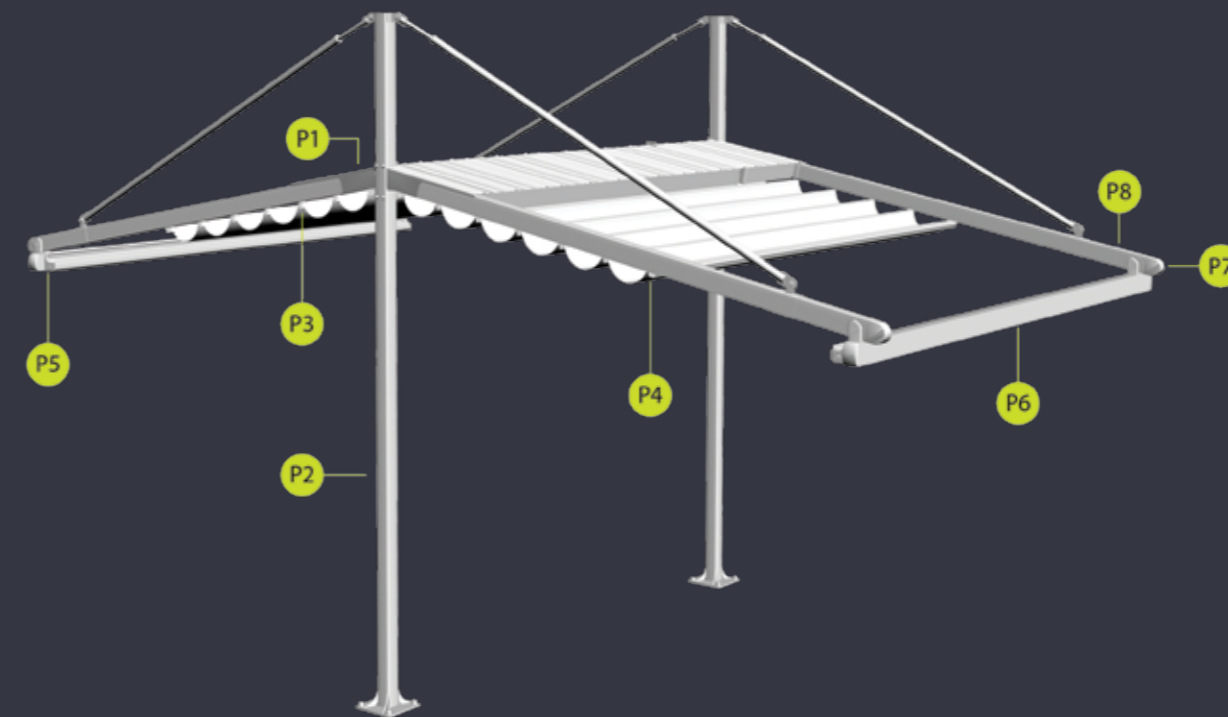



MARIN

DOUBLE TILTED

This elegant product is free standing and is a stylish way to enlarge your outdoor living space. The eye catching nautical design creates a welcoming atmosphere and ensures that you make the best out of your area. The product is usable in all-weather conditions and designed to be used in all four seasons.

Palmiye presents a wide range of ceiling covers, with a selection of colours, materials and patterns which are imported from Europe and U.S, with 5 years guaranty against fading and mould.

Lighting systems can be adapted to the ceiling cover which moves together with it.







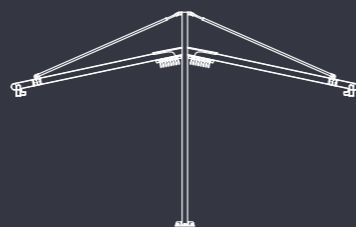

The Spot Lights or Linear Lights are installed on the aluminium profiles and can be controlled by a remote control or with a remote controlled dimmer function.

Each of our products is hand crafted and in itself unique, and from ceiling cover to the construction material you can completely customize your products.

Palmiye is proud to present its own MyPalmiye App which has been designed specifically for Palmiye products and is available at Apple's App Store.

width	1300
projection	1200
max rail centers	450



- P1 
Wall joiner finish
- P2 
Pillar
15 x 15
- P3 
Fabric support profile
4,5 x 5,6
- P4 
Fabric support profile front&back
8 x 5,6
- P5 
Gutter
13 x 13
- P6 
Front beam
10 x 15
- P7/1 
Rail end cap rounded
11,3 x 15
- P7/2 
Rail end cap square
11,3 x 15

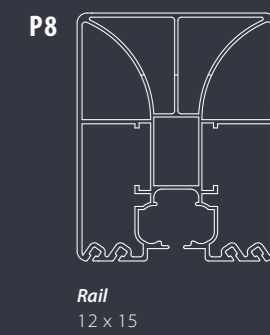
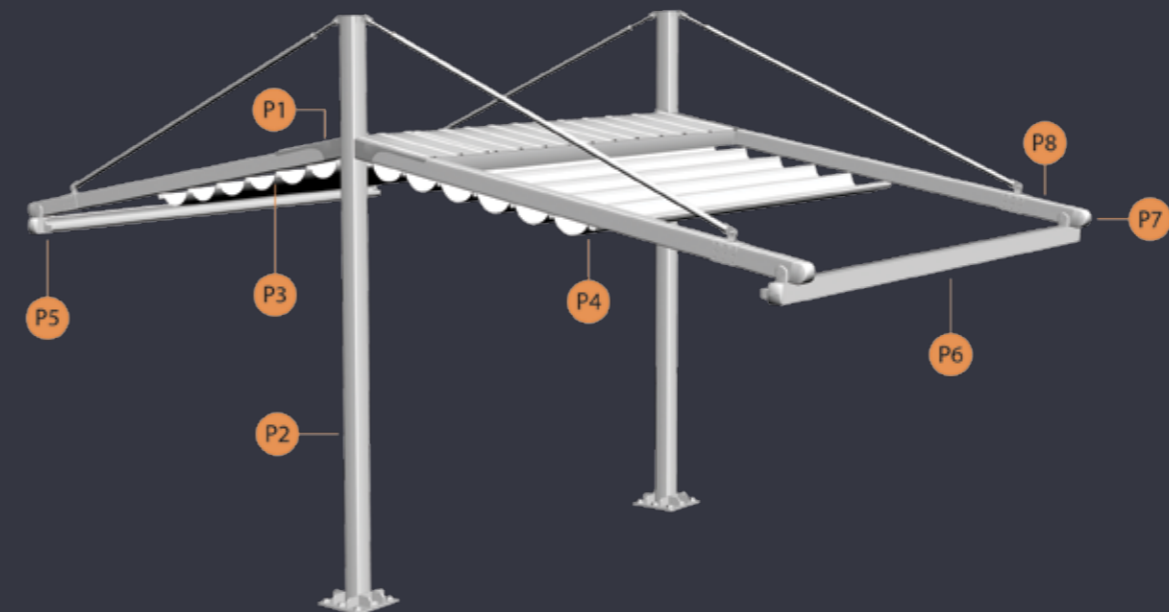



LEGEND

Legend enables you to enjoy the pleasant warmth and light the sun provides, when and how much you want.

Ensure uninterrupted interior climate control throughout the seasons and allow the elegant finish and clean lines to add aesthetically to your interior.



LEGEND

TILTED

Legend is an indispensable product, if there is an existing construction, this enables you to enjoy the pleasant warmth and light the sun provides, when and how much you want.

Palmiye presents a wide range of ceiling covers, with a selection of colours, materials and patterns which are imported from Europe and U.S, with 5 years guaranty against fading and mould.

Lighting systems can be adapted to the ceiling cover which moves together with it.

The Spot Lights or Linear Lights are being installed on the aluminium profiles and can be controlled by a remote control or with a remote controlled dimmer function.

Each of our products is hand crafted and in itself unique, and from ceiling cover to the construction material you can completely customize your products.

Palmiye is proud to present its own MyPalmiye App which has been designed specifically for Palmiye products and is available at Apple's App Store.

width	1300
projection	1000
max rail centers	450



P1
Fabric support profile
4,5 x 5,6



P2
Fabric support profile front&back
8 x 5,6



P3
Rail end cap
8 x 9

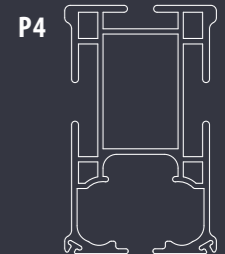
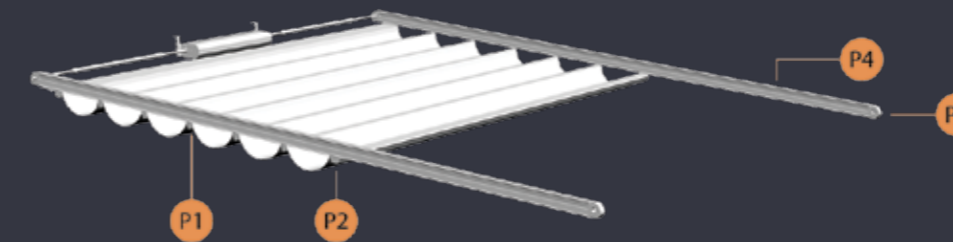

P4
Rail
5,5 x 9



COSMO

This attractive product with its elegant finish and clean lines allows uninterrupted interior climate control throughout the seasons.

With Cosmo you can experience the warm sunshine of spring, or the golden light of autumn exactly the way you want it!



COSMO

CURVED

Cosmo is an indispensable product, if there is an existing curved construction, which allows uninterrupted interior climate control throughout the seasons.

Palmiye presents a wide range of ceiling covers, with a selection of colours, material (such as PVC, fabric) and patterns which are imported from Europe and U.S, with 5 years guaranty against fading and mould.

Lighting systems can be adapted to the ceiling cover which moves together with it.

The Spot Lights or Linear Lights are being installed on the aluminium profiles and can be controlled by a remote control or with a remote controlled dimmer function.

Each of our products is hand crafted and in itself unique, and from ceiling cover to the construction material you can completely customize your products.

width	1300
projection	800
max rail centers	400



P1



Fabric support profile
4,5 x 5,6

P2



Fabric support profile front&back
8 x 5,6

P3



Rail end cap
8 x 9

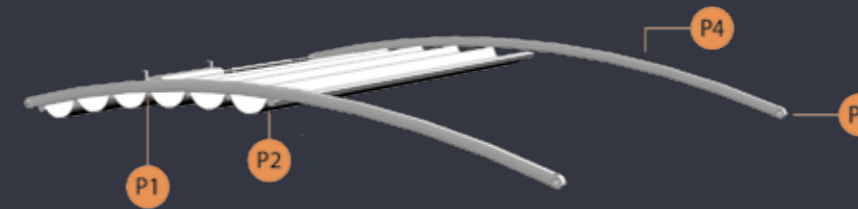

P4

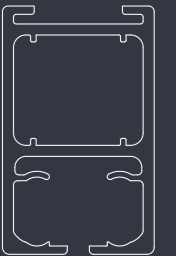

Rail
5,5 x 9

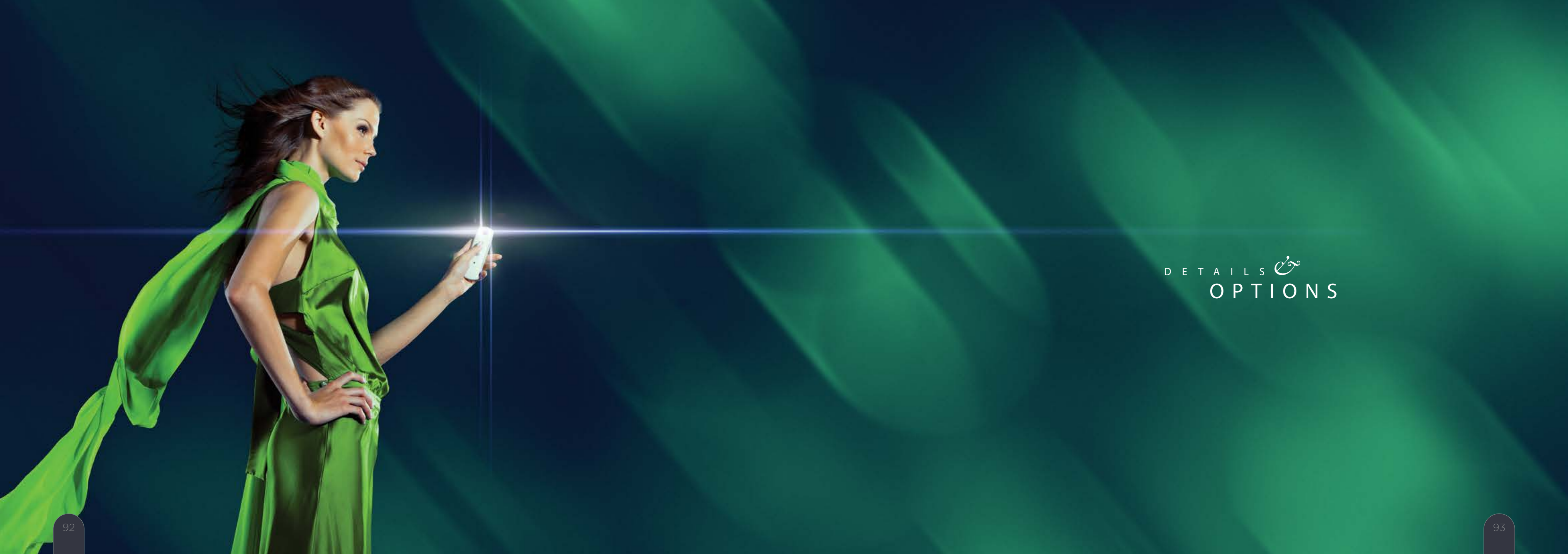

DETAILS 
OPTIONS



GLASS ENCLOSURES

Enclose your Product with various Glass Systems and create a Wind- and Watertight Wintergarden. By that you can add indoor comfort to your Product and you get an outdoor living room.



AWNINGS & BLINDS

Horizontal sun rays can be reduced with a vertical blind. The full cassette awning protects the awning fabric from wind and weather.

Our special see-through fabric creates shade without interrupting the view and provides you the privacy need.

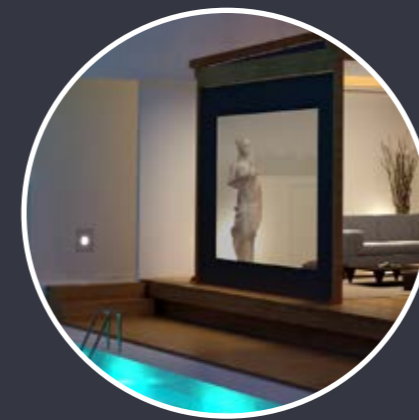

Vertical Zip Blind



Drop Arm Awning



Vertical Awning

MOTOR & AUTOMATION

Internationally renowned Somfy motors from France are used to operate all of our products. Guaranteed for 5 years and using RTS technology, the motors can be operated at the simple touch of a button.



Solar Sensor

DIMMABLE LED LIGHT

Depending on whether you want strong practical lighting, or an atmospheric dimmed ambience, you can choose between the Spot Lights with Palmiye's 3-Lens LED Technology or the Linear Lights. You can dim the lights directly from your Remote Control or Smart Phones.

Investing in LED technologies is part of Palmiye's contribution to a greener environment.

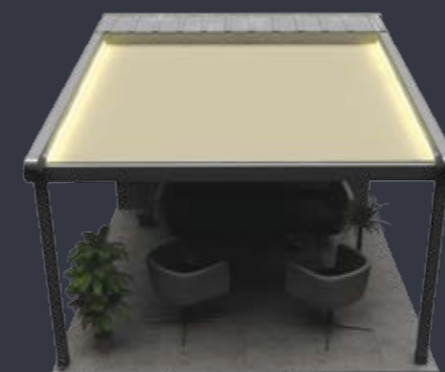

PALMIYE APPS

We are proud to present our own MyPalmiye App which has been designed specifically for Palmiye products and is available at Apple's App store.

Now you can take full control of your Palmiye experience and choose from several options, directly from your iPhone or iPad.

These include:

- Retract the Ceiling Cover.
- Dimming the lights.
- Control the Awnings & Blinds





CEILING COVER

Palmiye presents a broad range of Ceiling Covers with a wide selection of colours, patterns and elegant designs imported from the USA, France, Austria and France, and all with 5 years guaranty against fading and mould.

5 YEAR WARRANTY



 **White** FS-1210

 **Cream** FS-1230

 **Grey** FS-1260

 **Green** FS-1480

 **3D-White** 3D-1213

 **3D-Cream** 3D-1233

 **3D-Grey** 3D-1263

 **3D-Green** 3D-1483

 **White** 6002-20183

 **Vanille** 6002-10387

 **Bordeaux** 6002-20186

 **Navy** 6002-20189

 **White** W96-8102

 **Sandy** W96-1103

 **Grey** W96-2171

 **Black** W96-2047

 **SAT-White** PRO-SAT1218

 **FER-White** PRO-FER1258

 **FER-Grey** PRO-FER1269

 **Vibration** SUN-5372-120

 **Mink Brown** SUN-5007-120

 **Lead Chine** SUN-5002-120

 **Heather Beige** SUN-5476-120

 **Charcoal Tweed** SUN-5042-120

 **Wheat TEX** TEX-2015

 **Coal Tweed TEX** TEX-10087

 **White** 86-2044

 **Champagne** 86-2175

 **Turquoise** 86-50271

 **Alu** 86-2048

 **Concrete** 86-2167

 **Black** 86-2053

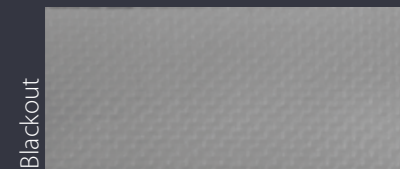

FS Flexy



FS Flexy 3D

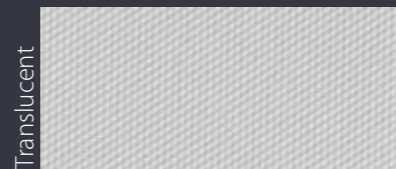

Stam 6002

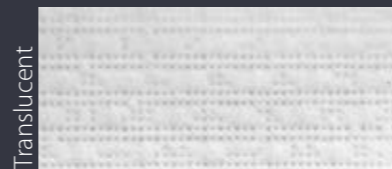

Ferrari W96

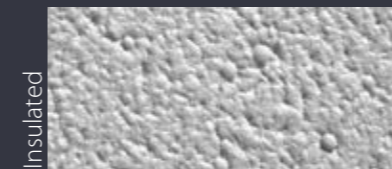

Izo-Pro



Deco



Flexy TEX





Soltis 86





ALUMINIUM COATING

All Powdercoating is being processed in our own production facilities and supervised by our Quality Control System. Our Powdercoating plant is based on the latest technology available.

 **Reinweiß** RAL 9010

 **Perlweiß** RAL 1013

 **Quarzgrau** RAL 7039

 **Blaßbraun** RAL 8025

 **Schokoladenbraun** RAL 8017

 **Tiefschwarz** RAL 9005

 **Weiß Metallic** SW3004

 **Anthrazit** PPMAT 617

 **Grau Metallic** MGT 92

 **Braun Metallic** PPMAT 613

 **Schwarz Metallic** PPMAT 611

 **Rosewood** 99061/825

 **Creol** 99297/066

 **Burma** 99061/868

 **Cedar** 99403/868

 **Teak** 99310/765

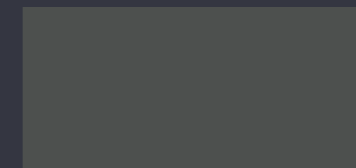

Standart RAL



Metallic Effect

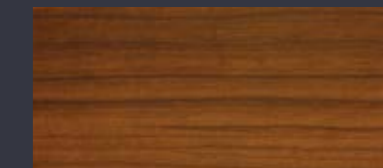

WOOD Effect

*The printed colour charts are for display purpose only and depend on the reproduction technique.

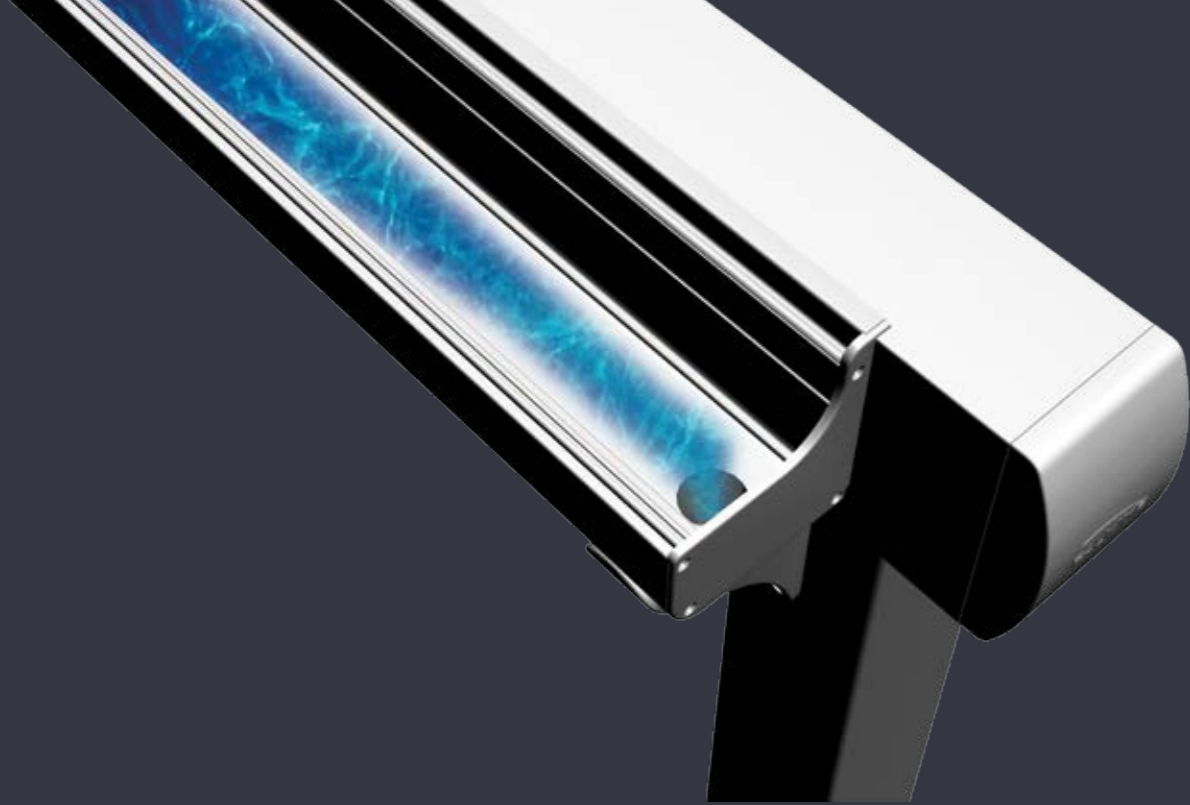

WATER DRAINAGE & DOWNPIPE



Specifically designed to add a nice aesthetic touch as well as being highly functional, this Integrated Drainage System (IDS) ensures that all water is smoothly drained inside the front pillar.

SEALS & WATERBLOCK

Double Anti-Air System

This system prevents the wind entering between the ceiling cover, rails and gutter, and creates an airtight space into which the wind cannot enter.

Waterblock

This prevents rainwater entering the enclosed area, and leads it directly to the front gutter for perfect water drainage.

Gutter Seal



Double Rail Seal & Waterblock



Back Seal



Trapezium Ceiling Cover
(max. width 900cm)

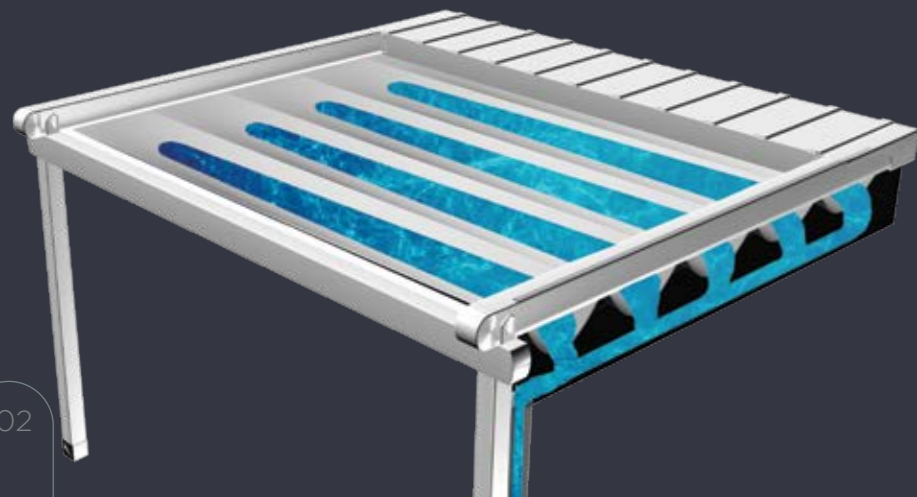

Wavy Ceiling Cover
(max. width 600cm)

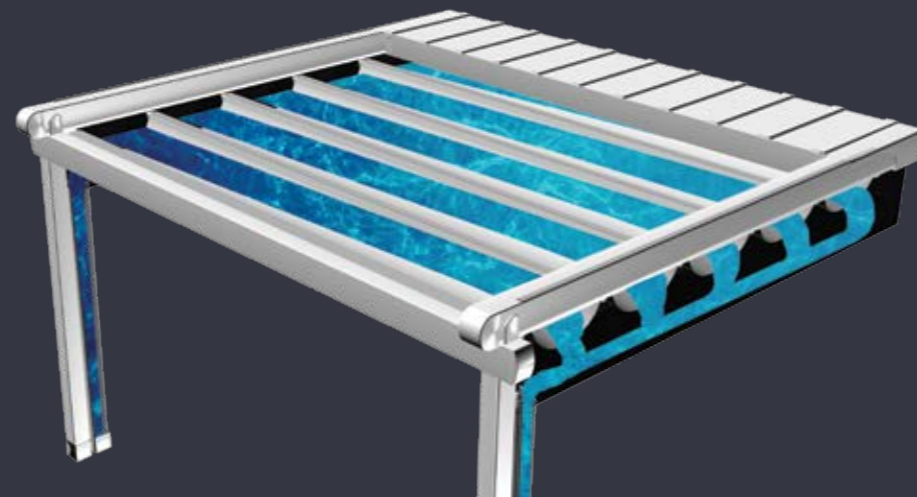



5-Years Warranty

All our products have up to 5 years guarantee for the construction, motor and fabric. The electronics and remote controls are guaranteed for 2 years.



CE, TÜV Certified

Distinguished by their design, durability and state-of-the-art detailing, all our products are certified by TÜV, ISO and CE.

Palmiye with an international network and organizational structure, is represented in many countries worldwide.

The values of each different culture and their unique architectural concepts, inspire and are reflected in Palmiye's products.

As an open-minded innovator, Palmiye operates sensitively, tailoring distinctive and incomparable products, where the thoughts and feelings of world famous architects and designers are brought to life.

Palmiye, through its team of professional designers, architects and engineers, shares possible solutions with customers and ensures that they experience the true meaning of the word "unique".

Taking their place within the ever growing 'smartphone' culture, the MyPalmiye App ensures that control of each product is now with the greatest of ease.

By channelling their extensive knowledge and experience with shade systems into retractable products, which can be used all year round, their professionalism has entered a new dimension.



*Expose
your outdoor world
to happiness.*



PALMIYE

www.palmiye.eu